

n o v e l t i e s 2 0 2 4



nowa szkoła

international

Dear Customers,

We are happy to present our 2024 Export catalogue featuring products exclusively launched this year. Particularly noteworthy are the Optima collection in a modern colour palette, the Master Kitchen furniture line, popular chairs in new contemporary colours, leisure furniture, sensory room aids, wall panels and 3D printing sets.

For over 32 years, we have been creating educational spaces and strengthening our position on the global market as a responsible producer and reliable business partner. We continually invest in modern energy-saving machines and equipment to shorten production time, increasing availability and variety of our offer.

By optimising production, we make every effort to meet our customers' expectations with respect for the environment.

In this catalogue, you will find what is new in 2024. If you would like to see our full offer, please refer to the Export Catalogue 2023 available online.



Export Catalogue 2023

Nowa Szkoła Team



OUR MISSION

Our core mission is to create space for education. With over 30 years of experience in the field, we strive to further develop the brand in accordance with the idea of corporate social responsibility. As nowa szkoła we do our best to follow the latest trends in education in a pro-social and ecological way while keeping children at the heart of everything we do.

EXPERIENCE



SATISFIED CUSTOMERS ON EVERY CONTINENT

We are active on the Polish and international market

- 40 000 clients in Poland
- 300 distributors around the world in nearly 60 countries



INTERNATIONAL CERTIFICATES AND STANDARDS

Each year more and more products undergo a certification process to prove their quality. During this process we have obtained the ISO 9001:2015 quality management system certificate - the audit covered the manufacturing facility as well as the warehouse in following areas: design, production, storage, and sale.



WIDE SELECTION

Every year we make our product selection richer and more diverse to cater for individual needs of clients. Everyone can find something for themselves, from nurseries, kindergartens, primary or secondary schools, children with special educational needs to seniors.

over
30
years experience on
the education market
from 1992

Based in Poland, we are a Polish company and a leader in the Polish and global educational market. As a company with more than 30 years of experience, we equally care about the product safety, quality and comfort of children and teachers.



POLISH MANUFACTURING FACILITY WITH MODERN MACHINE PARK AND WAREHOUSE

Thanks to the qualified team and modern machinery we are able to take on varied and ambitious projects. Our recently built A+ high

storage warehouse was designed in accordance with the principles of sustainable development which is confirmed by BREEAM certification.



nowa szkoła we care



SUSTAINABLE PRODUCTION

Nothing good goes to waste. We minimize waste through efficient resource planning. Leftover materials from cutting processes are repurposed for additional production. Shredded foam fills seats, and furniture boards are transformed into smaller elements.



RESPONSIBLE PACKAGING

We have successfully decreased cardboard usage by 5%, resulting in a tangible impact on product prices. This reduction not only minimizes waste but also helps conserve trees, as fewer are cut down for paper production. We prioritize the reuse of packaging from our suppliers for subsequent shipments. In cases where reuse is not feasible, damaged packaging is repurposed as filler material to ensure the protection of packaged products.



ECO CARDBOARD

For over 30 years, we have packaged all our educational games in boxes made from uncoated cardboard, without the use of varnish or film. As a sustainable alternative to plastic or wood, we offer cardboard drawers that have an equal lifespan while simultaneously reducing product costs.



ECO FUN

Our educational tools, toys, and play corners are crafted from sustainably sourced wood that upholds biodiversity and ecological balance. Additionally, our plastic containers and toys are composed of 25% recycled materials, further contributing to our commitment to environmental sustainability.



SUSTAINABLE ORDER MANAGEMENT

Our modern high-bay warehouse, situated in central Poland at a motorway intersection, is equipped with automated order-picking lines. The organization of the warehouse processes enables us to optimize route planning, save time and fuel, ultimately leading to a significant reduction in our carbon footprint.

REDUCTION OF POWER CONSUMPTION

Thanks to optimized production processes, modern energy-efficient machinery, and the use of LED lighting, we have successfully minimized our electricity consumption.



RECYCLING

We recycle and strive to reuse leftover resources. Recycling bins are strategically placed throughout our buildings to make recycling as convenient as possible.



TREE PLANTING

We have joined the tree-planting initiative, and we have planted as many trees as we have employees.



OUR WATER IS COOL

Instead of PET plastic bottles, which can take up to 1000 years to decompose, we provide reusable bottles and ensure that our employees have access to filtered water dispensers.



I WANT TO RIDE MY BIKE

We promote a healthy lifestyle by installing bicycle sheds outside our company. An increasing number of us choose to commute to work by bike.



BUSINESS FRIENDSHIPS

When establishing business relationships, we pay attention to pro-ecological certificates obtained by our partners, as well as their commitment to sustainability.





SUSTAINABLE PRODUCTION



ECO PLASTIC

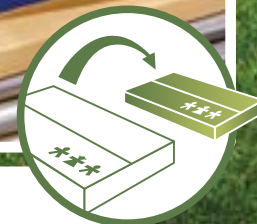

RESPONSIBLE PACKAGING



ECO CARDBOARD



TREE PLANTING



1 tree for employe per year



FURNITURE



OPTIMA

The new furniture collection called Optima was designed for the efficient and inspiring use of educational space. It offers a full range of storage and arrangement possibilities to make the most of any interior. Optima's classic aesthetic gives even the most unusual rooms a harmonious and organised look which is particularly beneficial in educational settings such as nurseries, kindergartens and schools. It is ideal for classrooms as well as headteachers' or teachers' offices thanks to its impressive versatility and functionality. The offer includes elegant storage units available in five sizes with the possibility of customising their interiors by adding compact containers as well as shelves in two variants. Moreover, the furniture range is enriched by tall cabinets with freely configurable fronts. To effortlessly create even more storage space, functional add-ons can be combined with cabinets or storage units. Mobile treasure islands in two different sizes are a perfect addition to the collection. This variety will ensure that each interior can be personalised to create a unique atmosphere.

Inspired by latest trends, Optima's muted colour palette maintains a cohesive space while allowing individual combination of available modules. Furniture fronts come in emerald blue, avocado, olive and sand colours to enhance the cosines of any room. Additionally, plastic containers match fronts from the Optima collection as they are offered in sand, olive, emerald blue and transparent. Such colour combination gives the interior a calm but friendly feel. Practical plinths not only make it easier to keep the underside of furniture tidy and clean but also prevent items from getting lost. The comfort of use is guaranteed by the wide recessed handle which does not protrude and keeps children safe. All furniture and doors are made of high-quality laminated chipboard, 18 mm thick, meeting the highest standards in terms of both durability and environmental friendliness. The wood comes from sustainable and controlled sources while 25% of the plastic used in the production of the containers is recycled to secure the best quality by respecting the environment in the process.

BODY

board: chipboard
thickness: 18 mm



birch

PLASTIC TRAYS

material: made with 25% recycled plastic



transparent



sand



avocado



emerald blue

SHELVES

board: chipboard laminated
thickness: 18 mm



birch

height adjustment: yes

board: HDF
thickness: 5 mm



white

height adjustment: no

DOORS

type: opened
board: chipboard laminated
thickness: 12 mm
surface: smooth
type of handle: cut-out



sand



avocado



olive



emerald blue

PLASTIC TRAYS

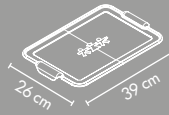
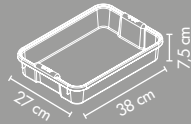
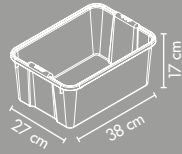

RUNNERS

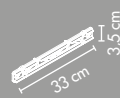

ADD-ON

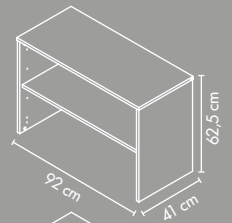

CABINETS

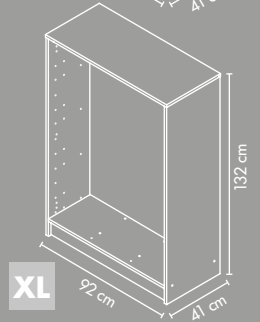
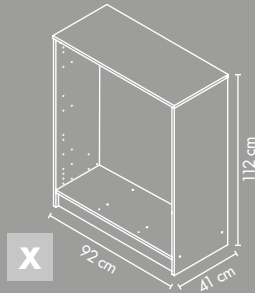
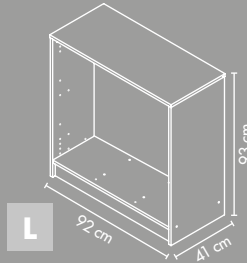
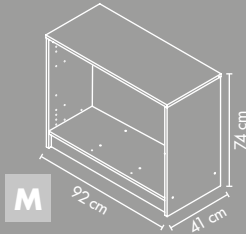
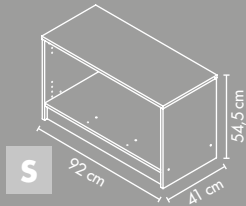

CABINET BODIES
chipboard laminated
18 mm birch

DOORS
chipboard laminated
18 mm in 4 colours:
sand, avocado, olive,
emerald blue

DOOR AND TRAYS HANDLE
harmoniously placed and
comfortable to open and close

PLASTIC TRAYS
high quality especially for use
in kindergartens and schools

TALL CABINET

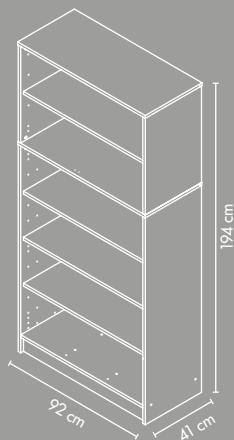

TREASURE ISLAND

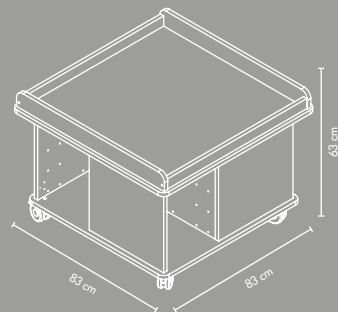
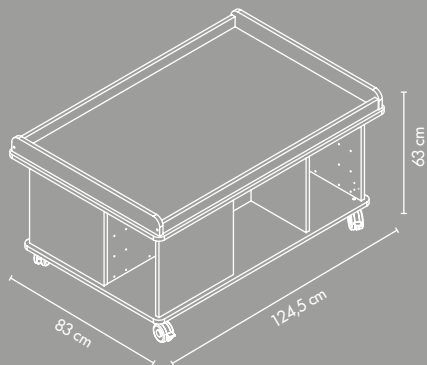

PLASTIC TRAYS
take up the harmony of the doors.
Transparent trays be able to easily
identify the content

LOCK ON THE DOOR
secure closure with lock

RUNNERS
strong, durable and able to
support heavy weight



PLASTIC TRAYS
specially designed,
can be inserted into
furniture with or without lid

SHELVES
fixed in 5 places

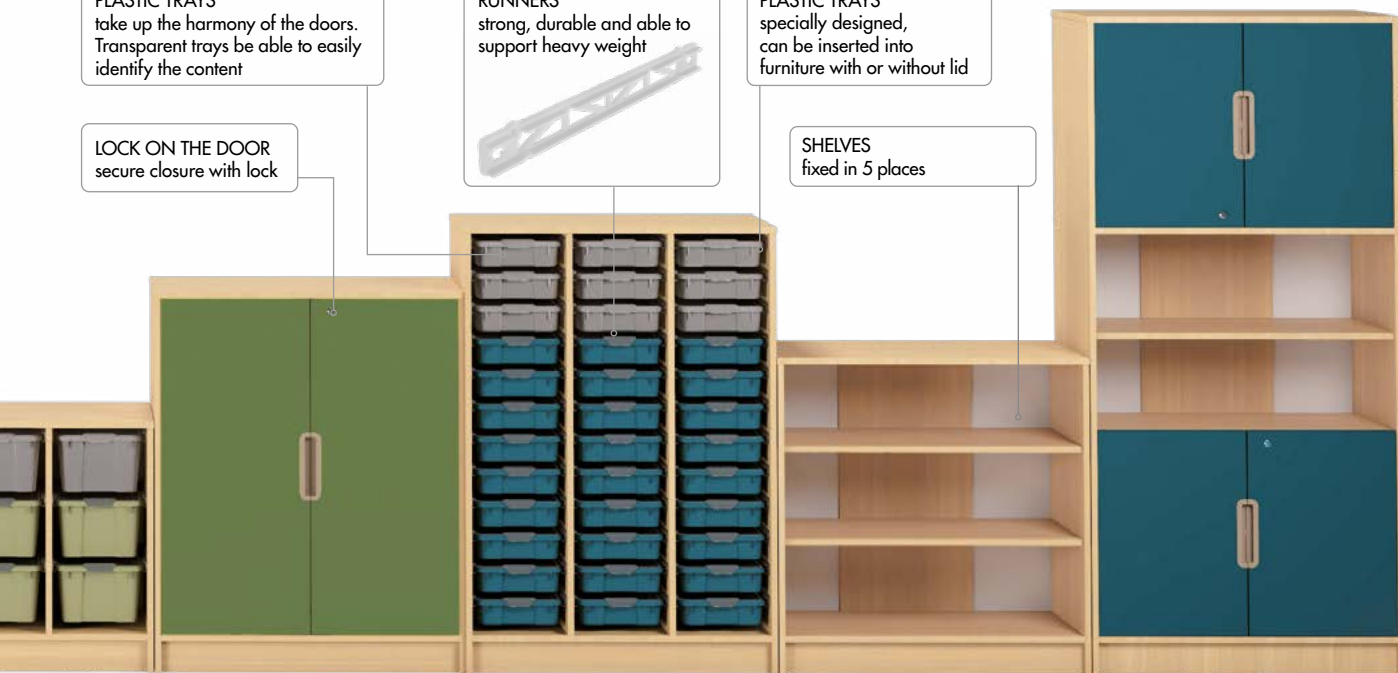



CABINETS FOR TRAYS

Containers sold separately.
Available on page 17.



S

OPT301

• dim. of the cabinet: 92 x 41 x 54,5 cm



M

OPT302

• dim. of the cabinet: 92 x 41 x 74 cm



L

OPT303

• dim. of the cabinet: 92 x 41 x 93 cm



X

OPT304

• dim. of the cabinet: 92 x 41 x 112 cm



XL

OPT305

• dim. of the cabinet: 92 x 41 x 132 cm

CABINETS WITH COMPARTMENTS



S

OPT331

• dim. of the cabinet: 92 x 41 x 55 cm



M

OPT332

• dim. of the cabinet: 92 x 41 x 74 cm



L

OPT333

• dim. of the cabinet: 92 x 41 x 93 cm



X

OPT334

• dim. of the cabinet: 92 x 41 x 112 cm



XL

OPT335

• dim. of the cabinet: 92 x 41 x 132 cm

CABINETS WITH SHELVES



S

OPT311

• dim. of the cabinet: 92 x 41 x 55 cm



M

OPT312

• dim. of the cabinet: 92 x 41 x 74 cm



L

OPT313

• dim. of the cabinet: 92 x 41 x 93 cm



X

OPT314

• dim. of the cabinet: 92 x 41 x 112 cm



XL

OPT315

• dim. of the cabinet: 92 x 41 x 132 cm



CABINETS WITH SHELVES AND DOORS

Sand

Avocado

Olive

Emerald-blue

3 shelves inside

optional with lock

1 shelf inside

2 shelves inside

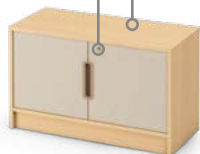









S • dim.: 92 x 41 x 55 cm

M • dim.: 92 x 41 x 74 cm

L • dim.: 92 x 41 x 93 cm

X • dim.: 92 x 41 x 112 cm

XL • dim.: 92 x 41 x 132 cm

| |  with lock | |  with lock | |  with lock | |  with lock | |  with lock | |
|---|---|-----------|---|-----------|---|-----------|---|-----------|---|-----------|
|  | OPT311-A | OPT311-ZA | OPT312-A | OPT312-ZA | OPT313-A | OPT313-ZA | OPT314-A | OPT314-ZA | OPT315-A | OPT315-ZA |
|  | OPT311-B | OPT311-ZB | OPT312-B | OPT312-ZB | OPT313-B | OPT313-ZB | OPT314-B | OPT314-ZB | OPT315-B | OPT315-ZB |
|  | OPT311-C | OPT311-ZC | OPT312-C | OPT312-ZC | OPT313-C | OPT313-ZC | OPT314-C | OPT314-ZC | OPT315-C | OPT315-ZC |
|  | OPT311-D | OPT311-ZD | OPT312-D | OPT312-ZD | OPT313-D | OPT313-ZD | OPT314-D | OPT314-ZD | OPT315-D | OPT315-ZD |

TALL CABINET



Tall cabinet OPT341

The tall cabinet with shelves from the Optima furniture collection offers practical and functional storage space. Six niches provide effective storage for accessories. The flexibility to mount the shelves at any height adds to the cabinet's functionality.

- dim. of the cabinet: 92 x 41 x 194 cm



with doors

| | |
|--|----------|
| | OPT341-A |
| | OPT341-B |
| | OPT341-C |
| | OPT341-D |



with doors

| | |
|--|----------|
| | OPT342-A |
| | OPT342-B |
| | OPT342-C |
| | OPT342-D |



with doors

| | |
|--|----------|
| | OPT343-A |
| | OPT343-B |
| | OPT343-C |
| | OPT343-D |



with doors

| | |
|--|----------|
| | OPT344-A |
| | OPT344-B |
| | OPT344-C |
| | OPT344-D |

with doors and locks

| | |
|--|-----------|
| | OPT341-ZA |
| | OPT341-ZB |
| | OPT341-ZC |
| | OPT341-ZD |

with doors and lock

| | |
|--|-----------|
| | OPT342-ZA |
| | OPT342-ZB |
| | OPT342-ZC |
| | OPT342-ZD |

with doors and lock*

| | |
|--|-----------|
| | OPT343-ZA |
| | OPT343-ZB |
| | OPT343-ZC |
| | OPT343-ZD |

with doors and lock

| | |
|--|---|
| | - |
| | - |
| | - |
| | - |

* lock only on the upper doors

ADD-ON



Add-on OPT345

The add-on which can be fitted on all container cabinet sizes, with small or regular shelves and with doors from the Optima furniture collection to offer even more practical and functional storage space.

- dim. of the add-on: 92 x 41 x 62,5 cm



with doors and lock

| | |
|--|-----------|
| | OPT345-ZA |
|--|-----------|



with doors and lock

| | |
|--|-----------|
| | OPT345-ZB |
|--|-----------|



with doors and lock

| | |
|--|-----------|
| | OPT345-ZC |
|--|-----------|



with doors and lock

| | |
|--|-----------|
| | OPT345-ZD |
|--|-----------|

with doors

| | |
|--|----------|
| | OPT345-A |
|--|----------|

with doors

| | |
|--|----------|
| | OPT345-B |
|--|----------|

with doors

| | |
|--|----------|
| | OPT345-C |
|--|----------|

with doors

| | |
|--|----------|
| | OPT345-D |
|--|----------|



TREASURE ISLAND

The tabletop may be equipped with a soft city mat, sold separately. Available on Export catalogue 2023 on page 374



Treasure islands from the Optima collection are relatively small, mobile pieces of furniture that are both play tables and functional storage cabinets for toys. The spacious tabletop allows children to play with blocks, do jigsaw puzzles and, after laying down special mats, trace the town's roads with

toy cars. Side slats contain toys within the tabletop and keep the floor clean to ensure safety of children in the shared space. The wheels make moving the treasure island easy, and its functionality is enhanced by the option of adding doors, shelves and containers.



**Treasure Island
OPT501**

Treasure island has got four wheels out of which two are lockable for easy moving around the room.

- dim. of the treasure island: 83 x 83 x 63 cm
- dim. of the tabletop: 76 x 76 cm

example of configurations

- accessories sold separately



with small trays and doors



with doors



with small and big trays



**Treasure Island Double
OPT502**

Treasure island has got five wheels out of which two are lockable for easy moving around the room.

- dim. of the island: 83 x 124,5 x 63 cm
- dim. of the tabletop: 76 x 117,5 cm

example of configurations

- accessories sold separately



with small trays and doors



with doors



with small and big trays

Doors and shelves for treasure island

Doors without a lock and shelves for the treasure island from the Optima furniture collection. Thanks to these elements, it is possible to customise the interior of the cabinet by dividing the space with shelves and closing it off with doors. Doors are made of laminated chipboard, 18 mm thick, in sand beige colour. To make opening and closing easy and comfortable, they have got an ergonomic plastic handle in beige colour. The shelves are made of white HDF board, 5 mm thick, to guarantee stable storing of various accessories.

This set includes:

- doors – 2pcs
- shelves – 2pcs.
- dim. of the doors: 31,5 x 41 cm
- dim. of the shelf: 38 x 28 cm

| | |
|--|-----------------|
| | OPT503-A |
| | OPT503-B |
| | OPT503-C |
| | OPT503-D |



4 COLOURS

ERGONOMIC HANDLE

LOCK AGAINST FALLING OUT

IDEAL FOR A4 FORMAT

REINFORCED STRUCTURE

25% RECYCLED PLASTIC

2 SIZES:
SMALL AND BIG

PLASTIC TRAYS

transparent
 sand
 avocado
 emerald blue

Small

- material: made with 25% recycled plastic
- dim.: 27 x 38 x 7,5 cm



3 trays



6 trays



9 trays



12 trays

| | without runners | with runners | without runners | with runners | without runners | with runners | without runners | with runners |
|--|-----------------|--------------|-----------------|--------------|-----------------|--------------|-----------------|--------------|
| | ATE110-03 | ATE110-PR-03 | ATE110-06 | ATE110-PR-06 | ATE110-09 | ATE110-PR-09 | ATE110-12 | ATE110-PR-12 |
| | ATE111-03 | ATE111-PR-03 | ATE111-06 | ATE111-PR-06 | ATE111-09 | ATE111-PR-09 | ATE111-12 | ATE111-PR-12 |
| | ATE112-03 | ATE112-PR-03 | ATE112-06 | ATE112-PR-06 | ATE112-09 | ATE112-PR-09 | ATE112-12 | ATE112-PR-12 |
| | ATE113-03 | ATE113-PR-03 | ATE113-06 | ATE113-PR-06 | ATE113-09 | ATE113-PR-09 | ATE113-12 | ATE113-PR-12 |

Big

- dim.: 27 x 38 x 17 cm
- material: made with 25% recycled plastic



3 trays



6 trays



9 trays



12 trays

| | without runners | with runners | without runners | with runners | without runners | with runners | without runners | with runners |
|--|-----------------|--------------|-----------------|--------------|-----------------|--------------|-----------------|--------------|
| | ATE120-03 | ATE120-PR-03 | ATE120-06 | ATE120-PR-06 | ATE120-09 | ATE120-PR-09 | ATE120-12 | ATE120-PR-12 |
| | ATE121-03 | ATE121-PR-03 | ATE121-06 | ATE121-PR-06 | ATE121-09 | ATE121-PR-09 | ATE121-12 | ATE121-PR-12 |
| | ATE122-03 | ATE122-PR-03 | ATE122-06 | ATE122-PR-06 | ATE122-09 | ATE122-PR-09 | ATE122-12 | ATE122-PR-12 |
| | ATE123-03 | ATE123-PR-03 | ATE123-06 | ATE123-PR-06 | ATE123-09 | ATE123-PR-09 | ATE123-12 | ATE123-PR-12 |

Set of runners

Runners for Optima collection containers are a practical addition to the set to increase its functionality. Thanks to the special design of the runners, containers are self-locking when placed in the furniture to prevent them from accidentally falling out. They are made of plastic that is 25% recycled, which underlines their lower environmental impact.

- dim.: 3,5 x 1,5 x 32,2 cm; material: plastic



| | |
|----------|-----------|
| 6 pairs | ATE100-06 |
| 12 pairs | ATE100-12 |

Transparent lids

Transparent lids for Optima collection containers are a practical addition to lock the contents inside and keep them tidy and safe in one place. Additionally, the lids make it easy to carry, which increases the functionality and mobility of the storage space. They are made of plastic that is 25% recycled, which underlines their lower environmental impact.

- dim.: 25,4 x 2,5 x 38,6 cm
- material: transparent plastic



| | |
|-------|-----------|
| 3 pcs | ATE190-03 |
| 6 pcs | ATE190-06 |

| | |
|--------|-----------|
| 9 pcs | ATE190-09 |
| 12 pcs | ATE190-12 |

The **Flexi Space** was created to ensure flexibility and versatility in educational spaces. Modules allow teachers to freely design classrooms according to specific needs of students as the collection is multifunctional by enabling different elements to be used both as tables and seats. An added benefit is the stackability of the pieces to effectively save space, especially when it is

limited. Modules are made of laminated chipboard, 18 mm thick, in birch colour to provide exceptional durability in intensive daily use, as well as an aesthetically pleasing appearance. The back is made of the same high-quality laminated chipboard in white colour. 18 mm thick laminated chipboard in birch colour.



Module XS
BBW210

- dim.: 58 x 28,5 x 21 cm



Module S
BBW260

- dim.: 62 x 28,5 x 26 cm



Module M
BBW310

- dim.: 66 x 32 x 31 cm

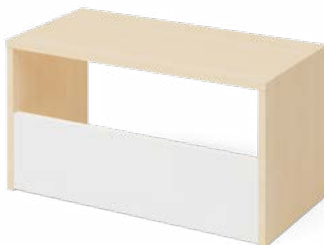

Module L
BBW400

- dim.: 70 x 34 x 40 cm

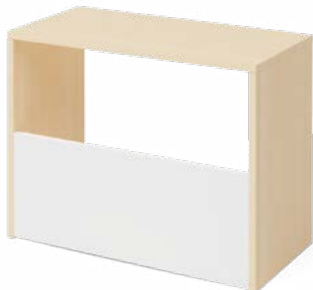

Module X
BBW590

- dim.: 74 x 36 x 59 cm

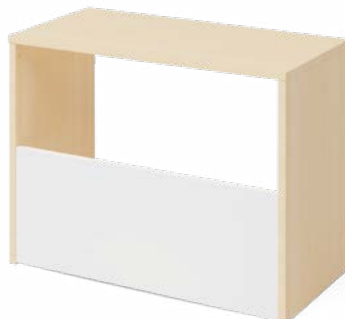

Module XL
BBW760

- dim.: 78 x 38 x 76 cm





FLEXI SPACE

Versatile and easy to rearrange, the **Flexi Space** collection offers teachers a range of module sizes to design the learning space according to the individual needs of the users. Thanks to these features, Flexi Space furniture inspire creativity and encourage teachers to use innovative teaching methods. The Flexi classroom allow students to explore, learn, and play in different positions, which can increase their engagement and focus during the lessons. This solution not only is in harmony with the concept of flexible learning but also promotes the innovative approach to education by accommodating to different teaching styles. The Flexi Space collection supports modern educational practices by encouraging interaction and developing creative thinking.





MASTER KITCHEN

The Master Kitchen collection is versatile, functional furniture maintained in aesthetically pleasing, bright colours, designed for convenient storage of kitchen accessories and preparation of meals. Spacious and capacious cabinets

are available in two widths: 60 cm and 80 cm, as well as in standing and hanging versions. Standing cabinets are equipped with a shelf and a door or 3 spacious drawers. Hanging cabinets are equipped with a shelf or a shelf and a door. Comfort

of use is ensured by a system of quiet, slow closing, used both in doors and drawers. Drawers are equipped with metal side rails, which keep the dishes in place when pulling out the drawer. The use of 4 levelling legs under each standing cabinet makes it easy

to adjust the height of worktops. The legs are hidden behind a masking plinth. Standing cabinets require installation of a worktop available in 2 colour versions: crystal white and oiled oak.

UNO



UNO set.
Kitchen cabinet 80 cm with sink, faucet and worktop in crystal white colour
KU0001

- 1 x KU80011 Standing kitchen cabinet 80 cm with doors
- 1 x Worktop with hole for sink
- 1 x NAO001 Recessed single-bowl sink with siphon
- 1 x NAO002 Single lever kitchen faucet
- length of set: 80 cm

WHITE TOP

UNO



UNO set.
Kitchen cabinet 80 cm with sink, faucet and worktop in oiled oak colour
KU0011

- 1 x KU80011 Standing kitchen cabinet 80 cm with doors
- 1 x one-piece Worktop with hole for sink
- 1 x NAO001 Recessed single-bowl sink with siphon
- 1 x NAO002 Single lever kitchen faucet
- length of set: 80 cm

OAK TOP

DUO



DUO set right 1.60 m with worktop in crystal white colour
KU0002

- 1 x KU80011 Standing kitchen cabinet 80 cm with doors
- 1 x one-piece worktop with sink opening
- 1 x KU80021 Standing kitchen cabinet 80 cm with drawers
- 1 x NAO001 Single-bowl sink with siphon (bowl on the right side, drainer on the left side)
- 1 x NAO002 Single lever kitchen faucet
- set length: 1,60 m

DUO



DUO set left 1.60 m with worktop in oiled oak colour
KU0003

- 1 x KU80011 Standing kitchen cabinet 80 cm with doors
- 1 x one-piece worktop with hole for sink
- 1 x KU80021 Standing kitchen cabinet 80 cm with drawers
- 1 x NAO001 Recessed single-bowl sink with siphon (bowl on the left, drainer on the right)
- 1 x NAO002 Single lever kitchen faucet
- set length: 1,60 m

DUO



DUO set right 1.40 m with worktop in crystal white colour
KU0004

- 1 x KU80011 Standing kitchen cabinet 80 cm with doors
- 1 x one-piece worktop with hole for sink
- 1 x KU60021 Standing kitchen cabinet 60 cm with drawers
- 1 x NAO001 Recessed single-bowl sink with siphon (bowl on the right side, drainer on the left side)
- 1 x NAO002 Single lever kitchen faucet
- set length: 1,40 m

DUO



DUO set left 1.40 m with worktop in oiled oak colour
KU0005

- 1 x KU80011 Standing kitchen cabinet 80 cm with doors
- 1 x one-piece worktop with hole for sink
- 1 x KU60021 Standing kitchen cabinet 60 cm with drawers
- 1 x NAO001 Recessed single-bowl sink with siphon (bowl on the left, drainer on the right)
- 1 x NAO002 Single lever kitchen faucet
- set length: 1,40 m

SETS



DUO



**DUO PREMIUM set right 1.60 m
with worktop in crystal white colour
KU0006**

- 1 x KU80011 Standing kitchen cabinet 80 cm with doors
- 1 x KU80021 Standing kitchen cabinet 80 cm with drawers
- 2 x KU80101 Hanging kitchen cabinet 80 cm
- 1 x one-piece worktop with hole for sink
- 1 x NA0001 Recessed single-bowl sink with siphon (bowl on the right, drainer on the left)
- 1 x NA0002 Single lever kitchen faucet
- set length: 1,60 m

DUO



**DUO PREMIUM set left 1.60 m
with worktop in oiled oak colour
KU0007**

- 1 x KU80011 Standing kitchen cabinet 80 cm with doors
- 1 x KU80021 Standing kitchen cabinet 80 cm with drawers
- 2 x KU80101 Hanging kitchen cabinet 80 cm
- 1 x one-piece worktop with hole for sink
- 1 x NA0001 Recessed single-bowl sink with siphon (bowl on the left, drainer on the right)
- 1 x NA0002 Single lever standing kitchen faucet
- set length: 1,60 m





TRIO

**TRIO PREMIUM set 2 m
with worktop in crystal white colour
KU0008**

- 1 x KU80011 Standing kitchen cabinet 80 cm with doors
- 1 x KU60021 Standing kitchen cabinet 60 cm with drawers
- 1 x KU60011 Kitchen cabinet 60 cm standing with door
- 1 x KU80101 Hanging kitchen cabinet 80 cm
- 1 x KU60101 Hanging kitchen cabinet 60 cm
- 1 x KU60111 Hanging kitchen cabinet 60 cm with a door
- 1 x one-piece worktop with hole for sink
- 1 x NA0001 Recessed single-bowl sink with siphon (bowl on the left, drainer on the right)
- 1 x NA0002 Single lever kitchen faucet
- set length: 2 m

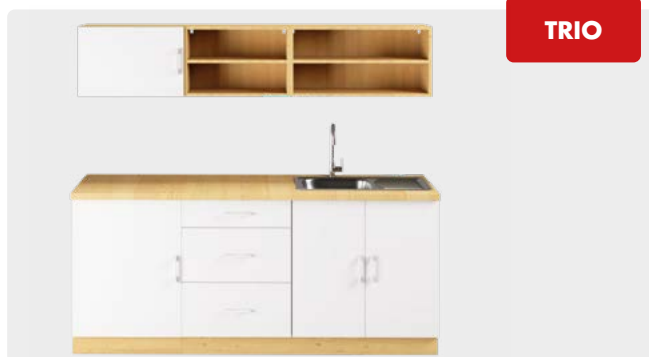

TRIO

**TRIO PREMIUM set 2 m
with worktop in oiled oak colour
KU0010**

- 1 x KU80011 Standing kitchen cabinet 80 cm with doors
- 1 x KU60021 Standing kitchen cabinet 60 cm with drawers
- 1 x KU60011 Kitchen cabinet 60 cm standing with doors
- 1 x KU80101 Hanging kitchen cabinet 80 cm
- 1 x KU60101 Hanging kitchen cabinet 60 cm
- 1 x KU60111 Hanging kitchen cabinet 60 cm with a door
- 1 x one-piece worktop with hole for sink
- 1 x NA0001 Recessed single-bowl sink with siphon (bowl on the left, drainer on the right)
- 1 x NA0002 Single lever kitchen faucet
- set length: 2 m



QUARTET

**QUARTET PREMIUM set 3,2 m
in crystal white colour
KU0009**

- 3 x KU80011 Standing kitchen cabinet 80 cm with doors
- 3 x KU80111 Hanging kitchen cabinet 80 cm with doors
- 1 x one-piece worktop with hole for sink
- 1 x KU80021 Standing kitchen cabinet 80 cm with drawers
- 1 x NA0001 Recessed single-bowl sink with siphon (bowl on the left, drainer on the right)
- 1 x NA0002 Single lever kitchen faucet
- set length: 3,2 m



QUARTET

**QUARTET PREMIUM set 3,2 m
in oiled oak colour
KU0012**

- 3 x KU80011 Standing kitchen cabinet 80 cm with doors
- 3 x KU80111 Hanging kitchen cabinet 80 cm with doors
- 1 x one-piece worktop with hole for sink
- 1 x KU80021 Standing kitchen cabinet 80 cm with drawers
- 1 x NA0001 Recessed single-bowl sink with siphon (bowl on the left, drainer on the right)
- 1 x NA0002 Single lever kitchen faucet
- set length: 3,2 m

CABINETS

KITCHEN CABINET

- material: frame made of 18 mm thick laminated particleboard in birch colour, drawers and door made of 18 mm thick laminated particleboard in white colour, back wall made of HDF in white colour
- handles in white colour
- 4 legs masked by plinth
- requires installation of top (available separately in 2 colours: crystal white KU90000 or oiled oak KU90001)
- if the cabinet is placed with one side outwards, then it requires installation of masking strip KU1001



– 60 cm with a door
KU60011

- dim.: 60 x 56.5 x 86 cm
- 1 shelf
- 1 door



– 60 cm with drawers
KU60021

- dim.: 60 x 56.5 x 86 cm
- 3 drawers: 2 with a height of 29.5 cm, 1 with a height of 15 cm



– 80 cm with doors
KU80011

- dim.: 80 x 56.5 x 86 cm
- 1 shelf
- 2 doors



– 80 cm with drawers
KU80021

- dim.: 80 x 56.5 x 86 cm
- 3 drawers: 2 with a height of 29.5 cm, 1 with a height of 15 cm

HANGING KITCHEN CABINET



– 60 cm
KU60101

- dim.: 60 x 33 x 39.5 cm
- 1 shelf
- material: body made of 18 mm thick laminated chipboard in birch colour, back wall made of HDF in white colour



– 60 cm with a door
KU60111

- dim.: 60 x 38 x 39.5 cm
- 1 shelf; 1 door
- material: body made of 18 mm thick laminated particleboard in birch colour, door made of 18 mm thick laminated chipboard in white colour, back wall made of HDF in white colour
- handles in white



– 80 cm
KU80101

- dim.: 80 x 33 x 39.5 cm
- 1 shelf
- material: body made of 18 mm thick laminated chipboard in birch colour, back wall made of HDF in white colour



– 80 cm with doors
KU80111

- dim.: 80 x 38 x 39.5 cm
- 1 shelf; 2 doors
- material: body made of 18 mm thick laminated particleboard in birch colour, doors made of 18 mm thick laminated chipboard in white colour, back wall made of HDF in white colour
- handles in white

KITCHEN WORKTOPS

- depth 60 cm, thickness 3.8 cm
- material: chipboard with HPL laminate
- placement of the sink cutout in the countertop customized to the order



| Length | Crystal white | Oiled oak |
|--------|---------------|-----------|
| 60 cm | KUB0600 | KUB0601 |
| 80 cm | KUB0800 | KUB0801 |
| 100 cm | KU90000 | KU90001 |
| 120 cm | KUB1200 | KUB1201 |
| 140 cm | KUB1400 | KUB1401 |
| 160 cm | KUB1600 | KUB1601 |
| 180 cm | KUB1800 | KUB1801 |
| 200 cm | KUB2000 | KUB2001 |
| 220 cm | KUB2200 | KUB2201 |
| 240 cm | KUB2400 | KUB2401 |
| 260 cm | KUB2600 | KUB2601 |
| 280 cm | KUB2800 | KUB2801 |
| 300 cm | KUB3000 | KUB3001 |
| 320 cm | KUB3200 | KUB3201 |
| 340 cm | KUB3400 | KUB3401 |
| 360 cm | KUB3600 | KUB3601 |
| 380 cm | KUB3800 | KUB3801 |
| 400 cm | KUB4000 | KUB4001 |

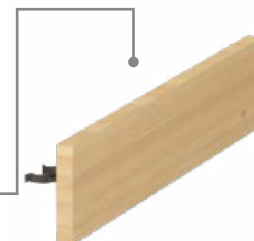

Side masking plinth

KU1001

Side masking plinth designed for standing cabinets from the Master Kitchen furniture collection. It should be

fixed at the floor to each visible side of the cabinet. It masks the gap resulting from the construction of the furniture.

- dim.: 46.3 x 1.8 x 9.8 cm
- material: body made of 18 mm thick laminated chipboard in birch colour





Cubo Line available in Export catalogue 2023 on page 68



Module 32
ZC3102

- Module with dimensions of 104 x 45 x 50 cm. Made of 18 mm thick particle chipboard in birch colour. It has two partitions that divide the space into 3 niches. In each of the niches on the slides are placed plastic trays. Included are 3 deep plastic trays in white and 3 deep plastic trays in grey.
- 1 x NC3191 Cubo 3 plastic trays cabinet. Birch
- 1 x NS2331 Plastic trays deep white 3 pcs.
- 1 x NS2330 Plastic trays deep grey 3 pcs.



Module 33
ZC2202

- Module with dimensions of 70 x 45 x 87 cm. Made of 18 mm thick particle chipboard in birch colour. It has 2 shelves and 1 partition, which divide the space into 4 niches. In each of the niches on the slides are placed plastic trays. Included are 4 deep plastic trays in white and 4 deep plastic trays in grey.
- 1 x NC2291 Cubo Medium 4 cabinet for plastic trays. Birch
- 1 x NS2333 Plastic trays deep white 4 pcs.
- 1 x NS2332 Plastic trays deep grey 4 pcs.



Module 34
ZC2303

- Module with dimensions of 70 x 45 x 125 cm. Made of 18 mm thick particle chipboard in birch colour. It has 4 shelves and 1 partition, which divide the space into 6 niches. In each of the niches on the slides are placed plastic trays. It comes with 6 deep plastic bins in white and 6 deep plastic trays in grey.
- 1 x NC2391 Cubo High 6 cabinet for plastic trays. Birch
- 1 x NS2337 Plastic trays deep white 6 pcs.
- 1 x NS2336 Plastic trays deep grey 6 pcs.



Module 35
ZC3304

- Module with dimensions of 104 x 45 x 125 cm. Made of 18 mm thick particle chipboard in birch colour. It has 2 shelves and 2 partitions, which divide the space into 9 niches. In each of the niches on the slides are placed plastic trays. It comes with 12 deep plastic trays in white and 6 deep plastic trays in grey.
- 1 x NC3391 Cubo High 9 cabinet for plastic trays. Birch
- 1 x NS2336 Plastic trays deep grey 6 pcs.
- 2 x NS2337 Plastic trays deep white 6 pcs.

SETS



Set 16. Cubo collection
CUBO0016

347 cm

Cubo furniture set with a total length of 347 cm and a maximum height of 124,6 cm, made of 18 mm thick particle chipboard in birch colour. The set consists of 4 furniture modules with 44 deep plastic trays in grey and white colours (25 white and 19 grey)



Fantasy

Fantasy Line available in Export
catalogue 2023 on page 30



FANTASY SETS ON LEGS



SET 1 FN2590

total length: 492 cm

- NS2588, FN2582, FN2581, FN2589,
FN2585, FN2584, FN2583

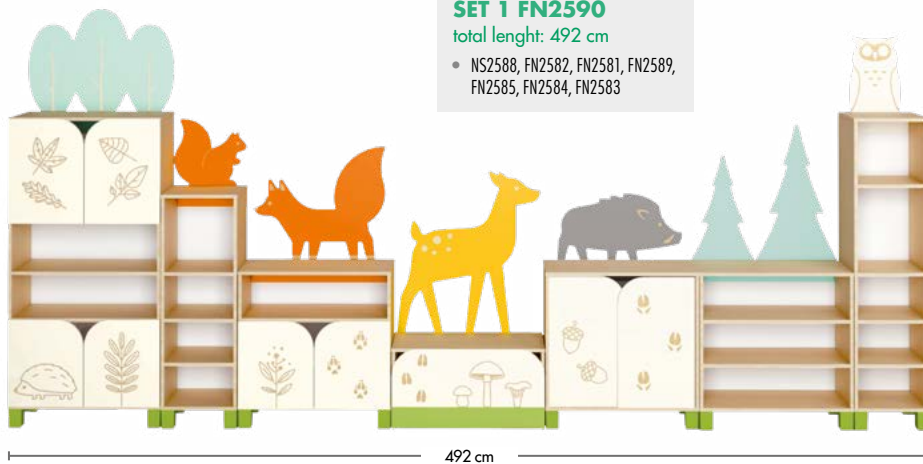



SET 2 FN2591

total length: 369 cm

- NS2588, FN2589, FN2585, FN2584, FN2583

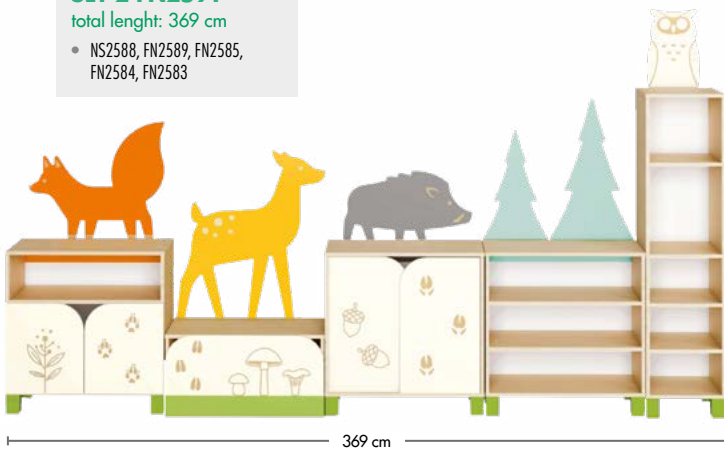

369 cm

SET 3 FN2592

total length: 287 cm

- NS2588, FN2585, FN2584, FN2583

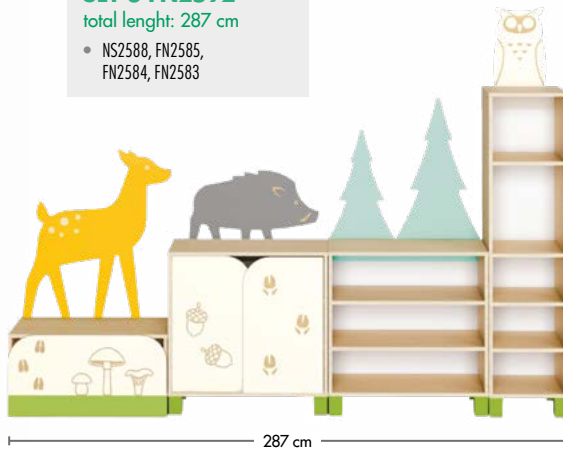

287 cm

SET 1 FN1865 total length: 492 cm; maximum height: 166 cm

- NS1868, FN1869, FN1870, FN1871, NS1872, NS1873, NS1874

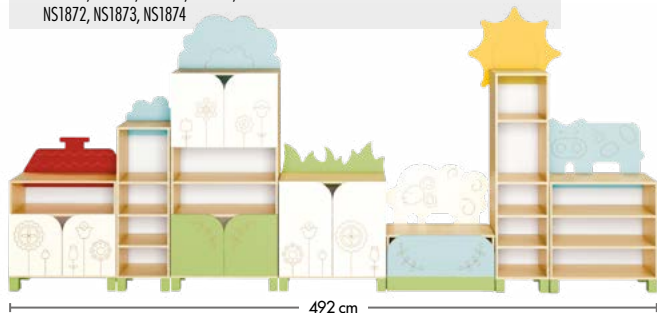

492 cm

SET 2 FN1866

total length: 369 cm

- NS1868, FN1869, FN1870, FN1873, NS1874



369 cm

SET 3 FN1867

total length: 287 cm

- NS1868, FN1870, FN1873, FN1874



287 cm



Farm



Jungle

SET 1 FN2800

total length: 492 cm

maximum height: 166 cm

- NS2811, FN2815, FN2817, FN2816, FN2812, FN2814, FN2813



492 cm

SET 2 FN2801

total length: 369 cm

- NS2811, FN2816, FN2817, FN2812, FN2813



369 cm

SET 3 FN2802

total length: 287 cm

- NS2811, FN2816, FN2817, FN2813



287 cm



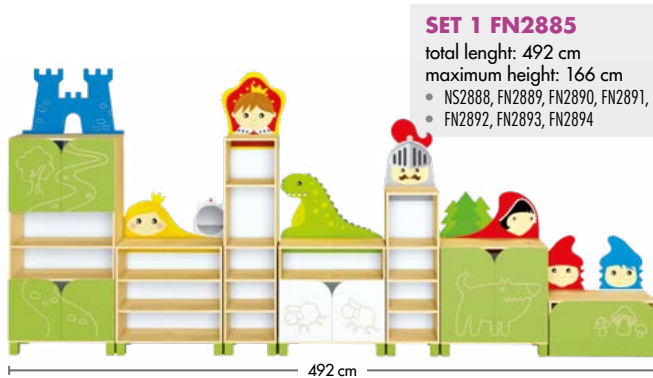

SET 1 FN2885

- total length: 492 cm
 maximum height: 166 cm
 • NS2888, FN2889, FN2890, FN2891,
 • FN2892, FN2893, FN2894

492 cm

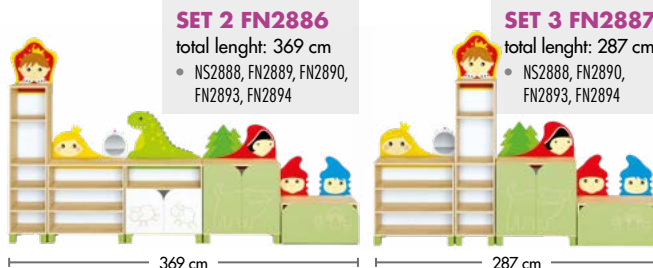

SET 2 FN2886

- total length: 369 cm
 • NS2888, FN2889, FN2890,
 FN2893, FN2894

SET 3 FN2887

- total length: 287 cm
 • NS2888, FN2890,
 FN2893, FN2894

369 cm

287 cm

Royal



Wave

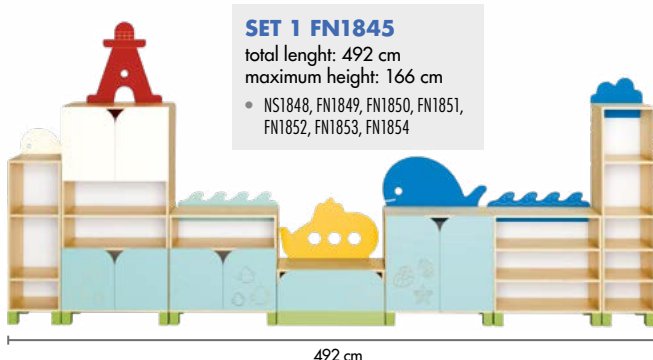

SET 1 FN1845

- total length: 492 cm
 maximum height: 166 cm
 • NS1848, FN1849, FN1850, FN1851,
 FN1852, FN1853, FN1854

492 cm

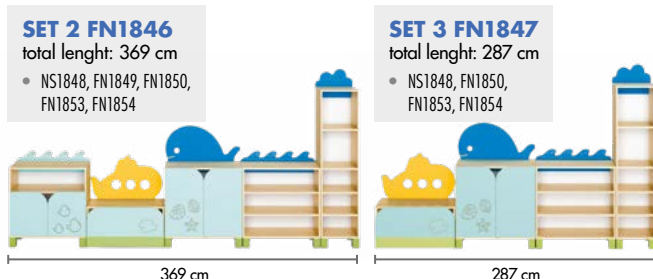

SET 2 FN1846

- total length: 369 cm
 • NS1848, FN1849, FN1850,
 FN1853, FN1854

369 cm

SET 3 FN1847

- total length: 287 cm
 • NS1848, FN1850,
 FN1853, FN1854

287 cm



Minty Line available in Export catalogue 2023 on page 18



MINTY

ADD-ON



Add-on for tall wide units. Minty collection NS3260

- dim. 99,5 x 40 x 70 cm
- made of 18 mm thick laminated chipboard in birch colour

DOORS



Add-on doors. Minty collection NS3261

- 2 pcs.; dim.: 49,5 x 1,2 x 71 cm
- 18 mm thick laminated MDF in white colour
- a silver plastic handle

NS3206 + NS3260 + NS3261

HANGING SHELF

Hanging shelf. Owl. Minty collection NS3290

- dim.: 32,5 x 16,5 x 42 cm
- made of 18 mm thick laminated MDF in white colour



Hanging shelf. Frog. Minty collection NS3291

- dim.: 32,5 x 16,5 x 25 cm
- made of 18 mm thick laminated MDF in green colour



EXCLUSIVE



EXCLUSIVE

Exclusive Line available in Export catalogue 2023 on page 166



DESKS

Headmaster's desk with 2 rows of shelves. Exclusive collection

- dim.: 183,5 x 60 x 76,5 cm, desk top with rounded edges, dim. 183,5 x 60 cm, made of 18 mm thick laminated chipboard
- the body is made of 25 mm thick laminated chipboard in birch colour
- 6 drawers, dim. 80 x 16 x 43 cm, the front is made of 18 mm thick laminated chipboard in birch or white colour, the sides are made of 18 mm thick laminated chipboard in white colour, the bottom is made of 6 mm thick white MDF board
- silver plastic handles



– birch front drawers EXC5271



– white front drawers EXC5273

TALL CABINETS WITH DOORS

Tall cabinet with doors. Exclusive collection

- dim.: 85,5 x 45,5 x 210 cm
- the body is made of 25 mm thick laminated chipboard in birch colour
- 2 pcs. Doors are made of 18 mm thick laminated chipboard in white or birch colour
- 6 niches; 5 shelves made of 18 mm thick laminated chipboard in birch colour; grey plastic handles



– with birch doors EXC1681Z



– with white doors EXC1683Z

BATHROOM



Bathroom washbasin 60 x 45 cm

NS4225

Furniture washbasin with the possibility of installation on a bathroom cabinet. With a hole for a faucet and an overflow. Mounted on screws.

- dim.: 60 x 45 cm
- hole for faucet Ø 35 mm
- material: ceramic
- weight: 17.3 kg
- colour: white



Faucet for sink

NS4226

Faucet, single lever with spout and automatic stopper.

- material: brass, chrome finish
- parameters: recommended working pressure: 1-5 bar
- max. temperature: +90°C
- control element: ceramic mixer with a diameter of 35mm
- flow class: A, flow rate 14.3 l/min at 3 bar pressure
- connection hoses G3/8" - M10x1 L=350mm
- automatic stopper with a string
- installation package; installation method: single-hole



Washbasin trap with fixtures

NS4227

- type: bottle half-siphon
- size: 11 x DN32
- material: plastic



Bathroom cabinet for washbasin NS2900

Ergonomic bathroom cabinet with sink recess and storage space for cleaning products.

- dim.: 51.5 x 41 x 79 cm
- material: body made of laminated chipboard in white, door made of laminated chipboard in turquoise
- adapted for washbasin NS4225, washbasin faucet NS4226 and siphon NS4227 (available separately)



METAL CLOAKROOM



More cloakrooms available on Export catalogue on page 282



Metal 4-person cloakroom with digital lock - size L.

- 4 niches; dim.: 80 x 48 x 185 cm
- sheet metal thickness before coating: 0,6 cm
- doors: 126,2 cm tall, 16,2 cm and 36 cm wide
- material: powder-coated sheet metal, one hanging rod, 2 hooks in each niche digital lock
- perforations for air circulation
- designated space for a name label

| | | |
|---|--------|---------------|
|  | grey | NG4704 |
|  | blue | NG4714 |
|  | yellow | NG4724 |
|  | green | NG4734 |

Master lock key with password finding tools for combination locks NG4700



- Master lock key (1 piece; material: metal)
- Password finding tools for combination locks - The tool should be placed in the rear hole of the lock. Then, turn the gears with digits one by one, starting from the top, until all of them are locked. The final code is the lost password. (1 piece; material: metal)

RIO SCHOOL DESKS WHITE CLASSIC CHAIRS



RIO school desk is an excellent combination of aesthetics, durability, and functionality. The desktop is made of sturdy laminated chipboard, 18 mm thick, in beech colour. The white desk frame ensures stability, thanks to the unique design and shape of the legs. To increase the desk's functionality, it is possible to instal additional shelves underneath the desktop as well as a practical backpack holder.



Grey Classic chairs and desks available on Export catalogue on page 254



**Shelf for RIO school desk
RIO915**

• dim.: 53,3 x 33 x 12 cm



**Hook for RIO school desk
RIO920**

RIO single school desk
• dim. of the desktop 60 x 50 x 1,8 cm

RIO double school desk
• dim. of the desktop 120 x 50 x 1,8 cm

| Size | Height | Single | Double |
|------|--------|--------|--------|
| 4 | 64 cm | RIO410 | RIO420 |
| 5 | 72 cm | RIO510 | RIO520 |
| 6 | 76 cm | RIO610 | RIO620 |

Classic school chair. White

Classic metal frame chair with a comfortable, profiled seat and backrest. Light colours of the wooden plywood and the white frame give the chair an elegant look which suits modern interiors. Chair leg inserts protect the floor from scratching and allow smooth sliding

- frame: powder coated metal in white colour
- seat and backrest: HPL laminated plywood in beech colour, 8 mm thick
- stackable



| | size | seat | overall | user's height | age |
|--------|------|-------|---------|---------------|-----------|
| NS1114 | 4 | 38 cm | 51 cm | 133–159 cm | 8+ years |
| NS1115 | 5 | 43 cm | 55,5 cm | 146–176,5 cm | 11+ years |
| NS1116 | 6 | 46 cm | 64 cm | 159–188 cm | 13+ years |



STANDING DESK

powered by electric engine

Solid tables made of 25 mm thick laminated chipboard in white or birch colour. Thanks to the electrically regulated height in the range from 61 cm to 126 cm, the desktop level can be individually adjusted to the user's height. The frame is powered by 230V ~ 110V and equipped with two motors for fast, smooth and quiet height-adjustment at 32 mm/s. They will prove useful

wherever there is a need to work at a single station for long periods of time but especially in schools or offices. The desktop level can be changed quickly, even to allow working while standing. From a health perspective, frequent repositioning is increasingly appreciated as well as the positive aspects resulting from this habit, such as improved focus, concentration and productivity.



Desktops for electric frame

The desktop made of laminated chipboard, 25 mm thick, is the perfect solution for a functional workstation. It caters to the individual needs of users when combined with the electric height-adjustable desk frame. The Edge protection of the desktop is made of

durable 2 mm thick PVC in multiplex colour. The full set with frame is available separately under the code NTX1000, to ensure a harmonious and ergonomic workspace in offices or educational institutions.

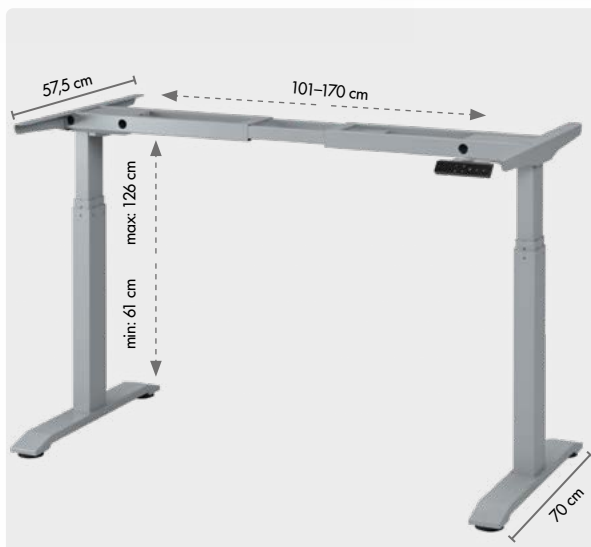

Frame with electric height-regulation

NTX1000

- colour: grey
- dim.: 101 - 170 x 57,5 x 61 - 126 cm

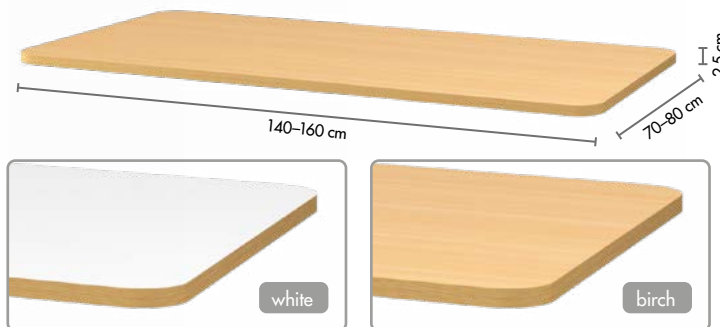

| Length | Depth | White | Birch |
|--------|-------|---------|---------|
| 138 cm | 68 cm | NTX1470 | NTX1479 |
| 138 cm | 80 cm | NTX1480 | NTX1489 |
| 150 cm | 80 cm | NTX1580 | NTX1589 |
| 160 cm | 80 cm | NTX1680 | NTX1689 |

BUTTERFLY CHAIR



More chairs available
in Export catalogue
on pages 254-268



Butterfly chair mint

Profiled one-piece seat and backrest.

- material: plastic
- the chair is stackable



STOOL



43 cm



Daisy stool YC0012

Stool with a comfortable seat of the lightweight design. Chair leg inserts protect the floor from scratching and allow smooth sliding.

- dim.: diam. of the seat: 30 cm; height: 43 cm
- material: seat made of synthetic fabric, steel frame; stackable

| | Height | Seat | Overall | Child height | Age |
|--------|--------|-------|---------|--------------|------|
| YC0006 | 0 | 24 cm | 45 cm | 80–95 cm | 1–2 |
| YC1006 | 1 | 26 cm | 51 cm | 93–116 cm | 2–6 |
| YC2006 | 2 | 31 cm | 55,5 cm | 108–121 cm | 4–7 |
| YC3006 | 3 | 35 cm | 64 cm | 119–142 cm | 6–10 |
| YC4006 | 4 | 38 cm | 70 cm | 133–159 cm | 8+ |
| YC5006 | 5 | 43 cm | 77,5 cm | 146–176,5 cm | 11+ |
| YC6006 | 6 | 46 cm | 80,5 cm | 159–188 cm | 13+ |

SHELL CHAIR

Shell chair

Comfortable, profiled one-piece seat and backrest with metal legs. This form provides a dynamic support to relieve pressure on the spine and lumbar muscles, ensuring comfort despite several hours in a sitting position. Metal frame guarantees stability and durability and the handle makes it easy to move the chair to a different location.

- material: plastic, metal



Green-blue



Avocado



| | Avocado | NS5035 | NS5043 | NS5054 | NS5063 |
|-----------------|------------|------------|------------|--------------|------------|
| | Green-blue | NS5036 | NS5044 | NS5055 | NS5064 |
| Size | | 3 | 4 | 5 | 6 |
| Child height | | 119-142 cm | 133-159 cm | 146-176,5 cm | 159-188 cm |
| Seat height | | 35 cm | 38 cm | 43 cm | 46 cm |
| Recommended age | | 6–10 | 8+ | 11+ | 13+ |



WALL BOARDS AND DISPLAYS



More wall boards and display available in Export catalogue on pages 328

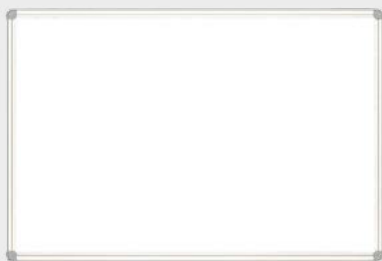

**Magnetic whiteboard. Size XL
YC9016**

- dim.: 240 x 1,5 x 120 cm, shelf width.: 5 cm
- material: varnished aluminium, light and pressure resistant filling of a durable corrugated cardboard
- fixing: for hanging on the wall using nail expansion anchors



**Folding magnetic whiteboard
YC9009**

- dim.: 340 x 100 cm
- 3 panels, two of them foldable inwards
- shelf for dry erase markers and a sponge
- material: honeycomb chipboard, varnished coated steel, aluminium
- fixing: for hanging on the wall



**Small display case
YC9017**

- display case dim.: 80 x 5 x 60 cm
- size of the cork inner surface: 66,5 x 46,5 cm
- lockable doors, opening upwards
- corners reinforced with ABS
- material: aluminium, hardened glass (0,5 cm thick), cork

media



**REST CORNERS
MEDIA ARMCHAIRS & POUFFES**

Wide, cosy armchair with backrest created for the use in public space, like schools, libraries, reading rooms, therapy rooms, or offices. The frame behind the backrest keeps the furniture piece stable and easy to move. The base of the armchair made of laminated chipboard and the inner reinforced frame provide additional support for

the seat and ensure durability and safety. Self-levelling legs make the armchair stable and they give the whole design a lightweight feel. Carefully selected fabric is characterised both by its softness to the touch and by its high density as well as resistance to creasing. These features guarantee comfort and durability.

- height of the seat: 40 cm; depth of the seat: 54 cm
- filling: high resilience polyurethane foam
- cover: dense fabric resistant to fading and discolouration, surface mass: 350 g/m² ± 5%, Martindale test: 60 000
- base: birch-coloured laminated chipboard, 18 mm thick
- back frame: powder coated metal, diam.: 2 cm; self-levelling plastic legs



Media armchair

- dim.: 70 x 60 x 65 cm (2 cm should be added to the seat depth to include the metal frame)

| | | |
|--|------------|--------|
| | light grey | NS3350 |
| | mint | NS3351 |
| | green | NS3352 |



Media corner armchair

- dim.: 70 x 70 x 65 cm (2 cm should be added to the seat depth to include the metal frame)

| | | | |
|------|--|------------|---------|
| LEFT | | light grey | NS3360L |
| | | mint | NS3361L |
| | | green | NS3362L |

| | | | |
|-------|--|------------|---------|
| RIGHT | | light grey | NS3360R |
| | | mint | NS3361R |
| | | green | NS3362R |



Media pouf

- dim.: 70 x 70 x 40 cm (2 cm should be added to the seat depth to include the metal frame)

| | | |
|--|------------|--------|
| | light grey | NS3370 |
| | mint | NS3371 |
| | green | NS3372 |

Foam seat which can also function as a table. Thanks to its unique clover shape, it is characterised by modularity. When combined with other seats from the collection, they create a well-fitted leisure space.

The seats of both available sizes can be put together.

- cover: abrasion-resistant, phthalate-free PVC fabric
- filling: high resilience polyurethane foam

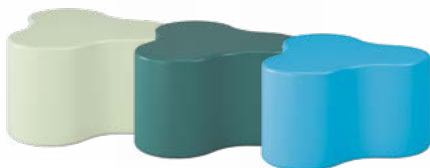

Clover pouffes

- height: 32 cm

| | | |
|--|-----------|--------|
| | mint | NS3380 |
| | green | NS3381 |
| | sea-green | NS3382 |



Tall clover pouffes

- height: 45 cm

| | | |
|--|--------------|--------|
| | emerald blue | NS3383 |
| | beige-grey | NS3384 |

example of configurations



- 2x NS3361L
- NS3361R
- 2x NS3351



Tabletop for Media poufs NS3379

A tabletop that allows you to easily transform poufs from the Media collection into a comfortable work table. Thanks to four non-slip pads in the corners, after placing it on the pouffe, the tabletop lies securely and stably in its place. It is a hard and secure base for a laptop, a cup of coffee and all necessary items needed during work, business meetings or rest.

- dim.: 68 x 68 x 1,8 cm
- material: laminated chipboard 18 mm, birch colour
- attachment to the pouffe using 4 corner, rubber, non-slip pads

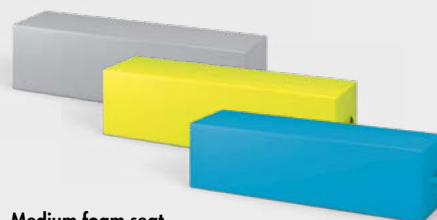

Medium foam seat

- dim.: 120 x 32 x 32 cm
- handles for easy transportation; abrasion-resistant, phthalate-free PVC fabric; non-slip underside of textured PVC fabric; filling: high resilience polyurethane foam

| | | |
|--|-----------|--------|
| | grey | NS3153 |
| | lime | NS3154 |
| | sea-green | NS3155 |

WALL PADDINGS

FOREST MOBILE WALL PANELS

Wall panels are the perfect way to decorate a room and create a cosy atmosphere. It is a practical and aesthetically pleasing solution ensuring an inspiring learning environment. The forest theme harmonises with the Forest Fantasy furniture collection what in turn makes up for a cohesive interior. The softness of the wall panel is a great advantage thanks to the foam filling, covered with easy-to-clean PVC fabric. Additionally, the panels reduce noise in the room, protect the walls from getting dirty and cushion any bumps. The hooks make installing and rearranging the wall panels easy and efficient. 6 prints depicting the forest ecosystem are available separately or as a set to match them to individual preferences and the design of the space in which they are used.

- dim. of the one panel: 56 x 3 x 102 cm



- UV printing
- reinforced wall pannels
- easy to attach to the wall
- corresponding to Fantasy Furniture Collection



– Tree and mushrooms
NS2594



– Firs and hares
NS2595



– Meadow with a bear
and roe deer
NS2596

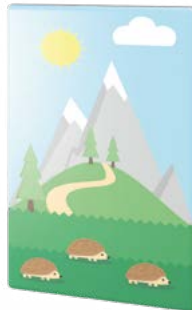

– Hedgehogs and hills
NS2597



– Deer
NS2598



– Fox and squirrel
NS2599

Forest mobile wall panel. Set NS2600

- the set includes 6 panels; dim. of one panel: 56 x 3 x 102 cm





FENCE

A mobile wall with a dual function that can act as a screen and a pillar protector. Thanks to its construction consisting of long foam ribs, the wall is easy to form, creating a space for playing or resting in the form of a small, intimate corner. On the other hand, the wall also lends itself easily to being rolled up and adapts perfectly to the cross-section and thickness of the pillars, protecting children from their edges and hard surfaces. Strong Velcro fasteners connect the ends of the wall well with each other and allow it to be extended at will, connecting further panels together.

- 5 foam ribs
- filling: high resilience polyurethane foam
- covering: PVC fabric
- fastened with snaps

Low fence 2 in 1. Soft screen and pillar protector

- dim.: 112 x 9 x 60 cm



– green
NS3390

– blue
NS3391

High fence 2 in 1. Soft screen and pillar protector

- dim.: 112 x 9 x 90 cm

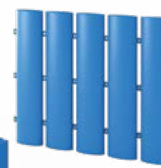

– green
NS3395

– blue
NS3396

REHABILITATION & ACTIVITY PLAY

SENSORIAL INTEGRATION SENSORY ROOM



Set of modular pieces which creates a bright, functional space in accordance with the **Snoezelen therapy** principles. The white colour is a characteristic feature of the multisensory room as it promotes rest, relaxation, concentration, and tranquillity by minimising visual stimulation. When lights are turned off, it transforms into the perfect space to display monochrome or multicoloured light emitted by projectors, fibre optics, LED

strip, LED tubes and other light sources. The set also includes platforms of the same height which, when stacked, form a stairs-like piece next to the white mattresses. Wall panels with big, safe, plexi mirrors create a sense of depth in the room. They enhance the experience and serve as a speech therapy aid. Individual sets can be freely combined to fit the size of the room thanks to the modularity of the collection.



– mirror wall

NS3197

- dim. 70 x 100 cm
- material: plexi
- holes for fixing to the wall



– Set
NS3190

Set of modular pieces which will allow you to create a bright, functional space in accordance with the Snoezelen therapy principles. The set includes:

- 1 x NS3192
- 2 x NS3191
- 2 x NS3194
- 1 x NS3193
- 1 x NS3196
- 1 x NS3195
- 6 x NS3197

WHITE MULTISENSORY ROOM



– low platform

NS3191

- dim.: 70 x 70 cm; height: 40 cm
- cover: abrasion-resistant, phthalate-free PVC fabric; reinforced inner chipboard frame padded with high-resilience polyurethane foam

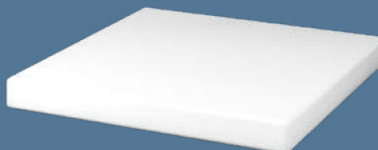

– low square mattress

NS3193

- dim.: sides: 70 x 70 cm; height: 10 cm
- cover: abrasion-resistant, phthalate-free PVC fabric; non-slip bottom from textured PVC fabric; filling: high resilience polyurethane foam



– low corner mattress

NS3195

- dim.: sides: 70 x 70 cm; height: 10 cm
- cover: abrasion-resistant, phthalate-free PVC fabric; non-slip bottom from textured PVC fabric; filling: high resilience polyurethane foam



– tall platform

NS3192

- dim.: 70 x 70 cm; height: 60 cm
- cover: abrasion-resistant, phthalate-free PVC fabric; reinforced inner chipboard frame padded with high-resilience polyurethane foam; 4 plastic legs; height: 10 cm

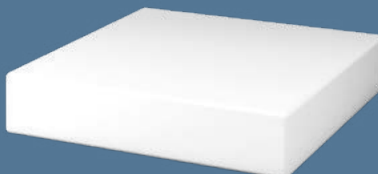

– tall square mattress

NS3194

- dim.: sides: 70 x 70 cm; height: 20 cm
- cover: abrasion-resistant, phthalate-free PVC fabric; non-slip bottom from textured PVC fabric; filling: high resilience polyurethane foam



– tall square mattress

NS3196

- dim.: sides: 70 x 70 cm; height: 20 cm
- cover: abrasion-resistant, phthalate-free PVC fabric; non-slip bottom from textured PVC fabric; filling: high resilience polyurethane foam

The therapy with the metal SI cage influences the correct development of the vestibular system, and when combined with other senses perceiving stimuli from the environment, it also has got a positive

effect on the sensory integration. It is designed to hold the weight of swings, beams, and suspended platforms in use. The sturdy metal frame ensures safety; however, the aid is always to be used

under adult supervision. Foam padding limits the risk of injuries during swinging and foam mattresses (sold separately) provide protection in the event of falls.



NS3111

NS3152

Wooden cages available in Export catalogue on pages 434

**Metal SI cage
NS3111**

Spacious and functional metal SI cage designed for suspended installation in sensory integration therapy rooms. Thick and stable metal frame holds the weight of swings, beams, and suspended platforms. It consists of 14 steel elements connected with metric screws. The two cross beams have a rail system which allows the equipment to be moved in one plane. 10 sturdy metal eyebolts, located on the 2 crossbars and the outer posts, enable the suspension of several single or double hook swings at the same

**Metal SI cage mattress
NS3152**

Mattress with cut out corners designed for the metal SI cage is an essential part

time. Foam padding ensures safety of users. When a foam mattress (sold separately) is placed on the bottom of the cage, it provides excellent insulation from the floor and protection in the event of falls. Floor mounting is possible. For indoor use only.

- dim.: 220 x 220 x 250 cm
- height of the foam padding: 130 cm
- thickness of the frame elements: 8 cm
- thickness of metal cross beams: 6 cm
- frame material: powder coated steel in white
- mattress and covers: high resilience polyurethane foam/PVC fabric; maximum load: 200 kg; 200 kg
- NS3152 mattress, sold separately

of the safe and comfortable therapy. It is made of high resilience polyurethane foam covered with grey PVC fabric.

- dim.: 110 x 110 x 4 cm



More therapeutic swings available in Export catalogue on pages 436



**Therapeutic illuminated swing
BO0538**

- dim.: diameter of 100 cm, height regulation up to 160 cm
- material: galvanized pipe with a diam. of 2,5 cm
- type of suspension: ropes with a diam. of 1 cm
- assembly: round mounting brackets (available separately) for a wooden SI cage
- material: polyester fabric, zinc, plastic
- LED tape, AAA batteries (not included)
- to be used only under adult supervision





White house. Hiding place BO2004

A white house which creates a cosy and private space for playing games, sensory therapy, or relaxation. The curtains in the windows can be rolled-up and secured with ribbons. The house requires self-assembly.

- dim.: 120 x 120 x 150 cm
- material: cotton, frame made of plastic; age: 3+

Light grey mattress for the tent NS3151

Soft, light grey mattress for the white tent. It is made of polyurethane foam covered with safe Oxford fabric to provide a comfortable relaxation space as well as secure playtime.

- dim.: 115,5 x 115,5 x 3 cm



Therapeutic pyramid NS3156

This soft playcorner allows children to hide inside it and feel safe far from external stimuli. Two open entrances allow to observe the surrounding while maintaining the sense of security and peace. The sides can be unfolded to create a large mattress. The pyramid is particularly helpful for autistic children with hyperactive and disturbances of deep sensation.

- diam. after when unfolded: 236 cm
- diam. when folded: 84 cm
- height: 107 cm
- cover: Oxford polyester fabric in light grey and azure colours
- zip fastenings
- filling: high resilience polyurethane foam



unfolded make
a large mattress



Cube. Construction house NS9074

Wooden structure designed for various activities and games. When covered with fabric, the structure turns into a cozy hideaway house, which can be used for resting, calming, playing house or as a reading corner. With the use of thicker fabric and soft lights, the house will turn into a magical place for sensory integration. Using other accessories, the house can be a store, post office or theatre. Placing mattresses and cushions inside will make it a pleasant and versatile place for play and relaxation.

- dim. of the structure 108 x 108 x 118 cm, dim. of the inner surface for the mattress 100 x 100 cm, dim. of the slat with a square cross section of 4 x 4 cm; material: solid beech wood
- dim. fit folding floor mattress 100 x 100 cm black and white NS2152 and colour NS2151



Sensory Sack S NS2264

Flexible sack recommended for stimulation of the proprioceptive system. It improves awareness of sensing one's own body, which is especially important for people with sensory integration disorders. By exerting pressure on the body, it also reduces self-stimulatory behavior. Increases concentration and develops motor coordination. The zipper makes it easy to put on and take off.

- 1 pc; size S; dim: length: 97 cm
- material: lycra; colour: turquoise

More sensory sacks available in
Export catalogue on pages 424



WEIGHTED AIDS

Weighted aids are specialist equipment in the therapy and rehabilitation of people with sensory integration disorders. While used, they gently press the body and stimulate the vestibular-proprioceptive system responsible for the 'deep touch'. Receptors in this system are found in muscles and tendons and they provide information about the orientation of our limbs in space. According to individual needs, stimulation of proprioceptors relaxes, calms down,

raises the awareness of one's body, improves focus and concentration, limits self-stimulation and helps eliminate fear, anxiety or insecurity. The aids for sensory integration are made of fabrics distinguished for colours, design and quality. They are filled with safe glass bead granulate whose amount and weight depends on the user's weight and height. All the products can be machine-washed at 30 degrees with light spinning, without having to remove the filling.

Weighted aids. Size XL

- recommended height: 155 cm and taller
- cover: Minky fabric with raised pattern in sand colour, white cotton
- filling: glass balls



Weighted collar. Size XL NS2247

- dim.: 50 x 60 cm
- weight: 2 kg; regulated snap buckle



Weighted vest. Size XL NS2262

- dim.: underarm width: 55 cm; length: 65 cm
- weight: 4,5 kg; regulated snap buckles



Weighted duvet. Size XL NS2261

- dim.: 100 x 150 cm
- weight: 5 kg



More weighted aids available on pages 429



Weighted roller NS2257

The roller is ideal for use in gymnastics, rehabilitation or yoga classes. It will also bring good results as a stress relief aid by applying gentle pressure on the body which will be especially appreciated by children with autism, hyperactivity, and sensory disorders. The filling in the form of glass microballs is safe, and the cover made of mint Minky fabric has got sensory dots. The handle on the side makes moving the roller easier. The aid is machine washable with the filling at 30 degrees with low-speed spinning.

- dim.: width: 70 cm, diam.: 20 cm; weight: 5 kg



Clothes protectors NS2258

The clothes protector keeps the garments clean and dry during eating or with uncontrolled salivation. The bottom part can be fastened to create a pocket. It is made of waterproof polyester fabric which prevents liquids from soaking into the clothing and allows stains to be easily washed off. The sides and the neck is equipped with snap fasteners.

- dim.: 50 x 50 cm
- it can be handwashed or machine washed at 60°C



THERAPY AIDS

Illuminated floor panel

A large, flat, illuminated floor panel filled with two-coloured oily liquid. The liquid creates amazing and mesmerizing effects when walked on. The non-slip surface provides additional sensory stimulation.

- dim.: 50 x 50 cm; material: aluminium, plastic, coloured gel; can be connected with other panels; requires constant connection to electricity

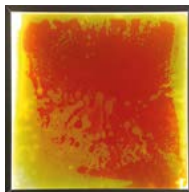

– Yellow
UT0064

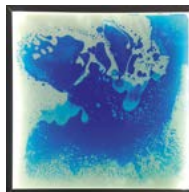

– Blue
UT0065

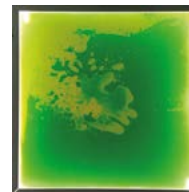

– Green
UT0066



– Purple
UT0067

SENSORY AIDS

Sensory floor panels

Sensory paths stimulate sensory receptors. When children follow the path made of natural materials, sensory stimuli of diverse intensities are processed by the nervous system. Different textures provide many physical sensations: prickly, soft, hard, cold etc. By proposing additional activities while on the path, like jumping or changing the height, children can train proprioception. Exercises which are properly prepared and adjusted to the child's age will help to develop all muscle groups and postural reflexes. They will also regulate muscle tension and train the sense of balance by affecting all motor functions.



Squares.
Set of 5 sensory floor panels
OM8560

- 5 panels; dim.: 30 x 30 cm
- beech wood, expanded clay „berry“, white pebbles, corks, small pebbles;
- age: 3+



Hexagons.
Set of 7 sensory floor panels
OM8577

- 7 panels; diagonal length: 27 cm
- material: wood, textures: coffee, purple expanded clay, chickpeas, corks, coconut fibre, soft, blue mop, blue flat glass balls; age: 3+



Circles.
Set of 8 sensory floor panels
OM8584

- 8 panels, dim.: diameter 15 cm, 25 cm, 30 cm and 35 cm
- material: wood, textures: pompons, metal nuts, soft fuzzy fabric, lentils, black stone, caoutchouc balls, artificial grass, Himalayan salt; age: 3+

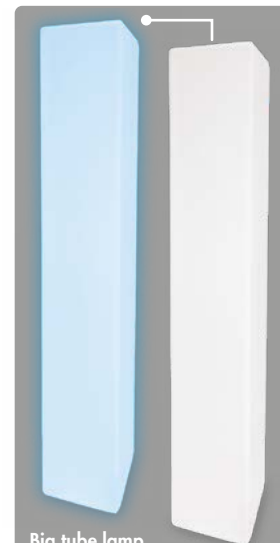

Big tube lamp
BW0002

Big, standing, milky tube sets a positive mood by emitting soothing, soft, and colourful light. The remote allows you to change colours. The tube is to be filled with water. Due to the height of the lamp, adult supervision is required.

- dim.: 31 x 31 cm, height: 181 cm
- power battery included
- material: plastic; age: 3+
- requires adult supervision

Gel triangles. Sensory panels UT0050

Flat panels filled with two-coloured liquid which when pressed creates wonderful visual effects. Children can press the panels with their hands, walk or jump on them to observe the magic flowing gel effect. The non-slip surface provides additional sensory stimulation while also ensuring safety.

- dim.: 33 x 33 cm; material: plastic, colourful gel; age: 3+



Sensory sequin mat UT0054

A light, soft, round board with sequin embroidered surface in two contrasting colours. After running a hand or a finger across its surface, the sequins turn and change colour to reveal the pattern created by you. This board can be used for writing, drawing or simply playing with patterns and colours.

- dim: ø 30 cm
- material: sequins, Oxford polyester fabric; age: 3+



Sensory Pop-It Hedgehog RV0041

Sensory hedgehog will help children to develop their senses. It makes characteristic „clicking“ sounds.

- Base; dim.: 15 x 15 x 15 cm
- 7 sensory balls
- material: plastic
- age: 3+



Coloured concave-convex mirror - set of 6 JN0016

Two-sided mirrors with a handle. One side is concave, the other is convex.

- 6 pieces in 6 colours
- dim.: 22 x 16 x 9 cm
- age: 18 months+



Turtles. Set of 4 rubber toys US0075

Soft rubber turtles filled with beads. They are a great addition to colour games, physical education classes, and sensory integration activities.

- 4 pieces
- dim.: 14,5 x 11,5 x 4 cm in 4 colours (green, yellow, turquoise, red)
- material: rubber; age: 3+



Sensory pop tubes NS4115

Elastic, colourful tubes which you can freely bended, stretched, and connected with each other to create long and complex installations. When pulled, they make characteristic sounds what adds to the sensory properties.

- 60 pieces in 6 colours (red, yellow, blue, green, orange, purple)
- dim.: length without stretching: 14 cm, diam.: 1,9 cm
- material: plastic; age: 3+



Rotating Star Projector RV0040

A round projector on a base which displays a pattern in the form of a night

sky. If the cover is not taken off, it can be used as a starry lamp providing a soft, subdued light. The projector has a few light modes to choose from: colour change or one colour, rotating or stopping the image.

Powered by an USB cable or batteries.

- dim.: 15 x 15 x 15 cm
- powered: USB cable (included) or 3 AAA batteries (not included)
- material: plastic; age: 3+

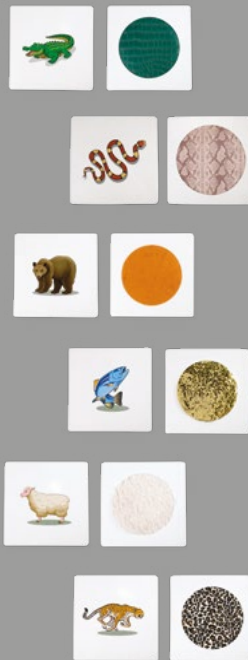

Sensory plates UT0052

Double-sided sensory panels with animal prints on one side, and textured fabrics on the other.

- 6 pieces, dim.: 16,5 x 16,5 cm
- material: plastic with UV print, textured fabrics
- 6 texture panels: a crocodile (glossy and cool, green eco leather), a bear (soft and warm, yellow faux fur), a fish (cool and rough sequins changing the colour from gold to black)
- a sheep (warm, rough, white faux fur), a cheetah (warm, smooth spotted velour), a coral snake (warm, velvety, eco leather with scales)
- age: 3+

Big sensory ball

Children can throw the ball to each other or aim at the bucket as well as play with it and squeeze in hands. The ball can be bounced off the floor to train reflexes. The insets on the ball make it bounce off in unpredictable directions so the toy promotes the development of motor skills, hand-eye coordination, and dexterity.

- 1 pc
- dim.: diameter of 10 cm
- age: 1 +



- Hedgehog RU0070



- Jellyfish RU0234



- Waves RU0231



Soft sensory elephant on wheels RU0129

The soft elephant on wheels is not only a sensory toy, but it also helps to develop coordination. It is entirely made of rubber foam, and the elephant is covered with velvety-to-touch nylon bristles.

- dim.: 20 x 12 x 13 cm
- age: 1+



Soft sensory car RU0189

Soft and velvety car with a handle. It can be easily grabbed and steered. The car as well as the tires are made of foam what makes them safe and quiet while playing.

- 8 vehicles: ambulance (red), railway engine (cobalt), police car (cobalt), 2 x passenger car (orange and turquoise) 2 x plane (red and lime), racing car (red)
- dim.: 12 x 8 x 12 cm
- age: 1,5 +



Sensory balls RU0190

The balls can be stroked, rubbed, squeezed and bounced off the floor or table to practice reflexes. They promote the development of motor skills, hand-eye coordination, and dexterity.

- 3 pieces
- basketball ball (orange), soccer ball (red), tennis ball (green)
- dim. of each ball: diameter of 6 cm
- age: 1 year+



Sensory shapes RU0249

Balls can be thrown, moved around and squeezed in hands. The insets make them bounce off in unpredictable directions what promotes the development of motor skills, hand-eye coordination and dexterity.

- 3 pieces: a ball with small insets (pink), a ball with big insets (green), a ball with holes (cobalt)
- size of the balls: diameter of 6 cm
- age: 2 +



Soft colourful sensory cubes RU0285

Soft and velvety cubes in vivid colours which can be arranged on a flat surface or used to build a high tower. They can also be connected to each other with additional pieces included in the set. All elements are soft and safe, even the act of "destroying" the tower is safe and almost silent.

- 9 cubes, dim.: 8 x 8 x 8 cm
- 14 connectors, dim.: diameter 4,5 cm, height 3,3 cm
- age: 2 +



Soft magnetic sensory train

RU0305

A big, sensory train with 3 cars and a railway engine connected with magnets. Thanks to their simple shape, pleasant texture and lightness, all elements can be grabbed easily. The set pieces are resilient, they can be squeezed and even safely thrown.

- railway engine and 3 cars
- dim.: 46 x 8 x 10 cm
- age: 3 +

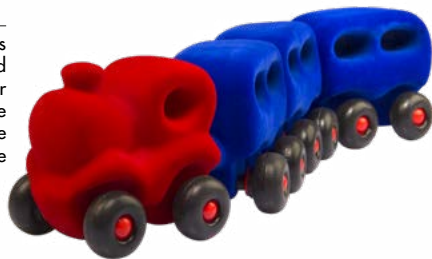

Soft sensory animals

RU0199

Soft and bouncy animal figurines which can be easily grabbed thanks to their round shapes. They can be stroked, turned around in hands and squeezed to help children recognise different textures and guess the animal. The activity with the toys develops motor skills, hand-eye coordination, and dexterity.

- 6 pieces: a rabbit, a dog, a cat, a cow, a horse, a pig
- dim.: 10 x 6 x 10 cm
- age: 2+



Soft sensory duck

RU0377

Soft and nice to touch rings which should be placed on the foam pole. At the top, there is a dedicated place for a small duck. The semi-circular base of the toy makes it swing sideways. All elements can be squeezed, kneaded and thrown on the pole.

- 7 pieces: a base with the pole, 5 rings of different diameters, duck figurine
- dim.: diameter of the base: 12,5 cm, height: 22,5 cm
- transparent bag with a handle
- age: 1 +



Soft sensory vehicles

RU0318

Light, velvety vehicles in vivid colours which can be easily grabbed thanks to their round shapes. Vehicles and tires are made of foam which makes them safe and quiet while playing.

- 8 vehicles: ambulance (red), railway engine (cobalt), police car (cobalt), 2 x passenger car (orange and turquoise) 2 x plane (red and lime), racing car (red)
- dim.: length approx. 12 cm
- age: 1,5 +



Soft sensory balls. Numbers and letters

RU0313

Soft and bouncy educational balls with multi-shaped insets (letters, numbers, geometrical shapes, and mathematical equations). Children can move them around or squeeze in their hands to discover different textures. The balls also promote the development of motor skills, hand-eye coordination and dexterity.

- 6 pieces: big letters (red and cobalt), small letters (pink), numbers and mathematical symbols (lime), geometrical shapes (turquoise and orange)
- dim.: diameter of 10 cm
- age: 1 +



Soft sensory balls. Bubbles

RU0372

Children can throw the balls to each other or aim at the bucket as well as play with them and squeeze in hands. The balls can also be bounced off the floor to train reflexes. The insets on the balls make them bounce off in unpredictable directions so the toy promotes the development of motor skills, hand-eye coordination, and dexterity.

- 6 pieces: big craters (red), small craters (cobalt), cones (turquoise), big bubbles (lime), medium bubbles (pink) insets (orange)
- dim.: diameter of 10 cm
- age: 1 +



SPORT EQUIPMENT

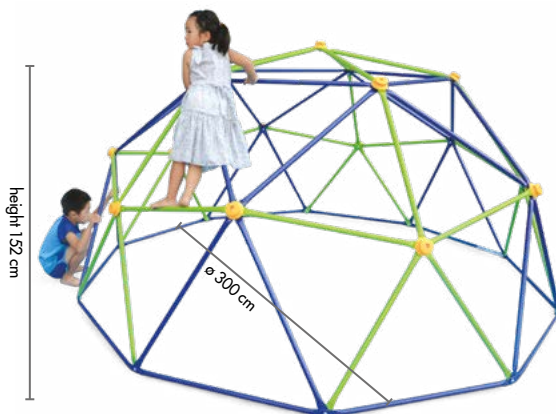

Monkey paradise. Climbing ladder

BO9081

- dim.: 300 x 300 x 152 cm
- weight: 44 kg
- structure made of galvanized steel pipes with a diameter of 2,5 cm
- 16 plastic connectors with dimensions: 8 x 8 x 3,5 cm
- maximum load: 100 kg
- does not require attachment to the ground
- for use under adult supervision
- age: 3+

Rowing machine 2. Exercise equipment

BO0113

- dim.: 94 x 36 x 50 cm
- material: metal, foam covered with PVC fabric
- max. load: 68 kg
- age: 4–8 years old



Climbing wooden arch

VG4710

The arch may be used as an obstacle course. Children can crawl or walk over it. When turned over, the aid changes into a swing for swinging and balancing.

- dim.: 95 x 70,6 x 42,6 cm
- material: beech wood, plywood
- age: 18 months +



2-person summer skis

UT0060

A set of skis designed for coordination and balance training. Requires focus, teamwork and communication within the group. The set is made of semi-elastic and non-slip material. It is very quiet in use.

- 2 pieces
- dim.: ski length 59 cm, ski width 14 cm, height including laces 74 cm
- material: "Eva" foam, plastic, age: 3+

PUZZLE MAT

- 12 pieces: 6 blue, 6 grey
- puzzle size: 32 x 1,3 x 32 cm
- material: "Eva" foam

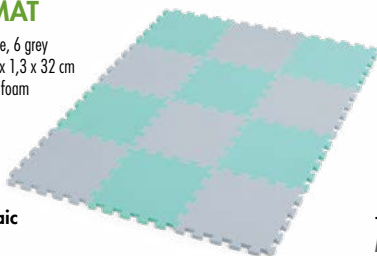

– green mosaic

MW0947

- 12 pieces: 6 green, 6 grey

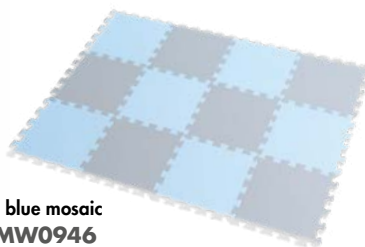

– blue mosaic

MW0946

- 12 pieces: 6 blue, 6 grey



Foam javelin

US0304

- 1 piece
- dim.: 90 x 5 cm
- material: "Eva" foam
- age: 3+

EDUCATION

MOTOR SKILLS

Soft manipulative cube NS2082

A large, soft educational and manipulative cube, on each wall it has a pair in the form of an animal, agricultural machine or building and an attribute associated with it (sheep - wool, cow - milk, hen - eggs, tractor - ear of grain, pig - ham, barn - straw). In addition, there is a different sensory activity on each side of the cube. The

fudge patch fastens with Velcro, the barn door closes with a zipper, the sheep has a string to thread through and tie on a bow, the hen's wing is fastened with Velcro, there are 3 straps on the side of the tractor, fastened with snap-on plastic buckles, and the piglet's nose is fastened with 2 buttons.

- dim.: 30 x 30 x 30 cm
- material: felt fabric cover with metal and plastic elements, polyurethane foam filling; age: 3+



Educational cuddly rabbit NS2097

Colourful, cuddly toy with long ears and other educational elements. The rabbit is wearing shoes with laces and Velcro. Its jacket has got 3 different types of buckles and a zipper. The t-shirt has a print of numbers and pictograms.

- height: 40 cm
- age: 3+



Giraffe - manipulative book UT0053

A fold-out book with different interactive elements on each page, including buckles and snaps, a zipper, laces, button fastening, counting frame, pin fastening, a weather wheel, geometric shapes with Velcro etc.

- dim.: 18 x 22 cm; material: felt; age: 3+



Spaceship - maze with beads CI0190

A labyrinth in the shape of a rocket taking off from Earth into space. The set contains many space-themed moving elements like astronauts, planets, and meteors.

- dim.: 26 x 26 x 22,9 cm
- material: wood, metal
- age: 18 months +

Farm - maze with beads VG9664

The aim of this activity is to move wooden butterflies and flowers along the wires of the maze. The magnetic farmer figurine can be placed in appropriate places.

- dim.: 21,5 x 14,5 x 22 cm
- magnetic farmer figurine
- material: wood, metal, magnet
- age: 1+



MANIPULATIVE BOARDS

Boards equipped with simple but functional elements encouraging manipulative play. Additionally, they are enriched with sensory tools which help children to develop creativity, logical thinking, perseverance, eye-hand coordination, and motor skills. Through play, children also learn new skills necessary in everyday life.



Manipulative board. Grey

RV0350

- dim.: 60 x 8 x 40 cm
- weight: 4,5 kg
- material: birch plywood in grey colour
- manipulative elements: lace-up shoe, xylophone, different locks, switches, wooden clock, shape matching game with Velcro, zip, belt with Velcro, board with patterns, labyrinth with an owl, mini abacus, beads on a string
- age: 3+



Manipulative board. Turquoise

RV0360

- dim.: 60 x 8 x 70 cm; material: birch plywood in turquoise colour; manipulative elements: lace-up shoe, xylophone, different locks, latch, bell, switches, wooden clock, shape matching game with Velcro, zip, belt with Velcro, board with patterns, labyrinth with an owl, wooden balls on a string, gears, mini abacus, numbers 0-9, hourglass with beads; age: 3+

Manipulative board. White

RV0370

- dim.: 60 x 8 x 70 cm; material: birch plywood in turquoise colour; manipulative elements: wooden clock, xylophone, different locks, light, numbers 0-9, 2 x shape matching game with Velcro, game with rotating beads, game with rotating images, lace-up shoe, manipulative labyrinth, chalkboard, zip, belt with Velcro, locking system, bell, wooden sensory balls; age: 3+



Steering wheel - manipulative board CI0171

A steering wheel, a plexiglass mirror, a labyrinth with a cloud, a sun, and a bird, a button, a knob

- dim.: 29 x 23,5 x 6,7 cm
- material: wood, metal; age: 1+



Fire brigade - manipulative board CI0168

- a moving window, a bell, a bear labyrinth, an abacus, a rotating sun and wheels
- dim.: 29 x 24,5 x 6,6 cm
- material: wood, metal
- age: 1+



Spaceship - manipulative board CI0170

- a rotating wheel with aliens, a magnetic astronaut helmet, an abacus, a labyrinth with planets; gears
- dim.: 29 x 23,5 x 6,4 cm
- material: wood, metal
- age: 1+

**Interactive sorting plane
NN0004**

Ride on shape-sorting plane. When the string is pulled or pushed by hand, the plane moves its eyes and starts turning propellers. The toy makes two types of sound, it talks or plays music, and it has got two language modes: English and Spanish. On the sides of the plane, there are four shapes holes. When the shape is matched correctly, a sound comes out of the speaker and children can hear its name. Buttons on the fuselage of the plane marked with shapes, letters, and digits also produce sounds and melodies. The tail is detachable so that the shapes can be taken out.

- switch: words/off/sounds; switch: English / Spanish
- material: plastic
- the set requires 2 AA batteries (not included)
- age: 12 months +

**Interactive steering wheel
NN0003**

The steering wheel is attached to the surface with a large suction cup. There is a small mirror on top of the steering wheel, and with each movement, the toy makes sound effects. When the ignition is switched on, the steering wheel produces the sound of the engine starting. Right next to it are placed the horn button (honking sound) and the gear lever (slowing down and speeding up sound). On the sides of the toy, there are four small buttons with different vehicles. Each of them makes the corresponding sound and it is accompanied by a visual effect.

- on/off switch; material: plastic, rubber
- the set requires 2 AA batteries (not included)
- age: 12 months +

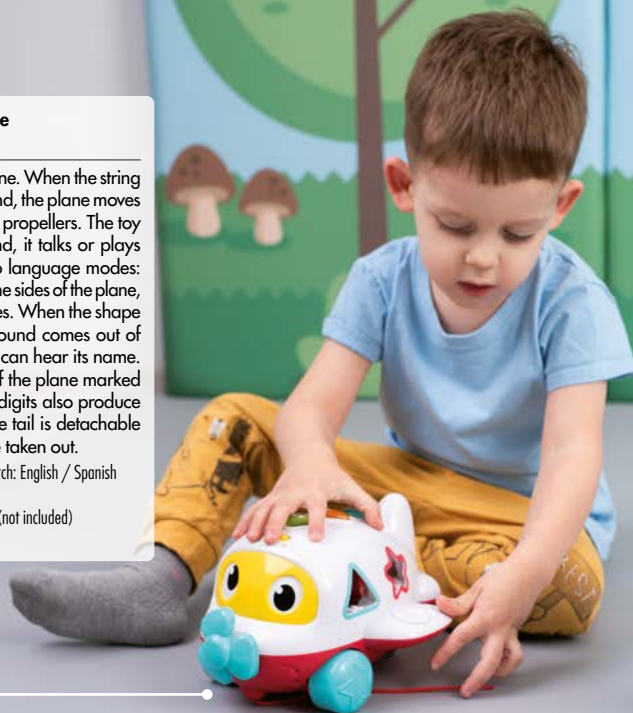

MONTESSORI EDUCATION



**Stand for frames. Montessori aids
AO0807**

A wooden stand with handles intended for display of 8 Montessori frames. It is possible to rotate it, use the middle section as a shelf or the top part as a table top.

- dim.: 32 x 32 x 110 cm
- material: beech wood

frames sold separately



More Montessori aids on pages 592-603

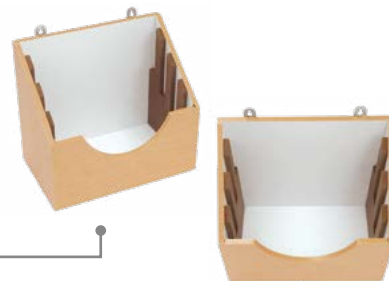

**Frames stand. Montessori aids
AO0808**

A stand with vertical runners for holding 4 frames. The design allows you to store the frames and keep them visible, which in turn ensures easy access. Thanks to the metal hooks, the stand can be hanged.

- dim.: 15 x 24 x 32 cm
- material: beech wood



ARTS&CRAFTS



Double sided board 3in1 with a tray CI4169

3in1 board - on one side it is possible to use chalk, and on the other, it has a dry-erase surface. The board can also serve as an easel, because it has a large clip for attaching sheets of paper. It is equipped with 4 paint or water containers as well as a useful tray for storing crayons, chalk and painting accessories.

- dim.: 58 x 63 x 113 cm
- material: wood, metal
- age: 3+



Giga stamps - set of 4 AP2062

4 textures: wave, grass, houndstooth, checkered.

- dim.: 14,5 x 7 cm
- handle with rubber band
- age: 3+



Family - wooden figurines for decorating AP2361

- 8 pieces, 4 heights
- dim.: height: 6–9 cm, width of the base: 2,3–3,3 cm
- material: wood
- age: 3+



Mega set of stamps and brushes AP2580

- 82 pieces:
- 6 x flat sponge brush (2 x width: 7,5 cm, 2 x width: 5 cm, 2 x width: 2,5 cm)
- 6 x lollipop sponge brush; width: 1,5 cm
- 6 x brush with bristles with a round handle; width: 4 cm
- 4 x flat texture brush; width: 3,5 cm
- 4 x sponge rollers; width: 7 cm;
- 4 x shape stamp with a long handle, width: 3 cm
- 6 x round stamp pictograms; width: 5,5 cm
- 6 x round stamp patterns with a round handle; width: 4 cm
- 4 x round stamp with a handle; width: 6 cm
- 8 x round stamp with a handle; width: 3 cm
- 6 x square stamp; dim.: 6 x 6 cm
- 4 x rocker stamp; width: 5 cm
- 18 x finger stamp (3 of each of 8 patterns); width: 1,5 cm
- age: 3+



MUSIC

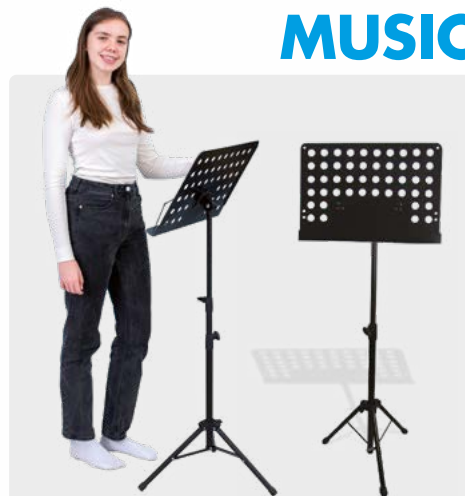

Music stand NT0905

Music stand on a height-regulated tripod.

- dim.: 63 x 42 x 59 cm
- height regulation: 88–150 cm
- material: powder-coated steel



Musical tubes NT8005

Colourful tubes of different lengths. Each of them, when lightly hit, produces the sound of the C major scale. The colour and letter coding allow children to easily find the proper tube and repeat the melody.

- 8 tubes with a diameter of 4,5 cm; length: from 28,7 cm to 61,3 cm
- in 7 colours representing the sounds: C, D, E, F, G, A, H(B), C
- material: plastic
- age: 3+



BBQ - wooden play corner VG4656

This BBQ set is equipped with 47 cooking accessories. You will find a spatula and tongs, plates, spices, vegetables, meat, bread and also boards with drawings of flames.

- BBQ stand on wheels with a lid. Dim.: 88,4 x 67,8 x 38,6 cm
- 49 accessories.: 5 x BBQ tools, 3 x corn, 2 x sausage, 2 x chicken, 2 x steak, 1 x broccoli, 1 x pepper, 1 x bacon, 1 x salad, 1 x burger, 2 x tomato (big and small), 2 x cucumber (big and small), 1 x onion slice, 1 x champignon, 2 x burger bun, 1 x slice of brawn, 1 x slice of ham, 1 x slice of cheese, 2 x prawn, 1 x salt, 1 x pepper, 1 x ketchup, 1 x mustard, 5 x board with drawings of flames; age: 3+

Farm - manipulative table VG4657

A wooden table offering many farm-themed manipulative activities. You will find a railway track with a train and wagon, rotating gears, shape sorters, a musical plate, a xylophone, a shape puzzle, a stack puzzle with poles, a metal bell, and windows with small surprises.

- dim.: 45 x 45 x 42,2 cm
- material: wood
- age: 18 months+



Spaceship - DIY corner CI0574

Use a screwdriver, a wrench, a hammer, a ruler, screws, nuts and gears to build your own spaceship. Spin the gears and go on an adventure in space.

- 51 pieces
- dim.: 46,4 x 28,8 x 56,2 cm
- material: wood
- age: 3+



Wooden workshop with tools VG4065

The workshop is equipped with a circular saw and many other accessories thank to which it will be possible to screw, saw and connect elements by them together or attaching them to the countertop.

- dim.: 47 x 27 x 67 cm, height of the countertop: 40 cm
- 48 pieces: 8 x board with holes, 5 x tools (measuring tape, wrench, circular saw, screwdriver, hammer), 4 x gears, 2 x wooden cubes with holes, 4 x cars, 4 x round table mat, 5 x set of threads with nuts in 5 colours, 4 x handle
- material: wood; age: 3+

DOLLS



Cuddly fairy
NS2091

Soft fairy doll with a golden thread in the hair, wings and a crown. The doll can also become a tooth fairy.

- height: 40 cm
- age: 3+



Ballerina - big soft doll
NS2092

Soft ballerina doll in a sparkling skirt, a bow in her hair and shiny ballet shoes.

- height: 75 cm
- age: 3+



Talking baby doll
NN0006

When the belly of this doll is pressed, it cries, coughs or calls for mum and dad. The baby doll can be cuddled, put in bed or in a pram.

- dim.: height: 30 cm; dressed in a 2-piece outfit; feeding bottle, dim.: 9 cm; material: plastic, polyester fabric
- it requires 3 AG13 batteries (included); age: 2+



Doll bathtime set
NN0001

The doll in a bathing suit with a bathtub and accessories. Water and a bath foam can be poured into the bath, and when the pump is pressed, real foam comes out of the handset of the shower. Once the bath is finished, the doll can be dried with a towel and dressed in a hooded bathrobe.

- dim. of the doll: 22 cm
- dressed in a 2-piece outfit
- dim. of the bathtub: 26 x 14,5 x 16 cm
- dim. of the duck: 4,5 x 4,5 x 4 cm
- dim. of the towel: 12 x 12 cm
- bath foam height: 5 cm; shampoo height: 5,5 cm
- material: plastic, polyester fabric, rubber; age: 2+

Doll feeding set
NN0002

- A doll, dim.: 22 cm tall, in three-piece clothing
- two-piece change clothing
- a plate of food, dim.: diam. of 8 cm
- 2 x cutlery, dim.: length: 7,5 cm
- a tube of fruit mousse, dim.: 4,5 cm
- material: plastic, polyester fabric
- age: 2+



White doll cradle
VG4235

White cradle with a duvet, a pillow and a carousel with stars and moons.

- dim.: 41,9 x 23 x 33,3 cm
- material: wood
- For dolls not bigger than 38 cm
- age: 3+

White doll pram
VG4236

White wooden pram with a pocket for accessories. Rubber wheels increase the pram's stability, protect the floor, and ensure quiet play.

- For dolls not bigger than 38 cm
- age: 3+



WOODEN TOYS



Wooden pastel railway set VG4406

This set consists of all needed accessories to build a happy animal town in which the main attraction are the railway tracks. To build the town, children can use buildings, animal figures, road signs, trees, vehicles and many track elements.

- 90 pcs.
- dim.: 132 x 100 x 18,8 cm
- material: wood
- age: 3+



Sticking puppy VG4042

To complete the puzzle, children should stack the rings on the pole in the correct order.

- base with a pole; 4 rings of different diameters, a dog head.
- diam. of the base: 8,2 cm, height: 13,3 cm
- material: wood
- age: 2+



Animals - wooden tower puzzle VG4457

The pyramid's elements can be hidden one inside the other or they can be used to build a high tower. The set consists of animal figurines and each tower storey is a home for one of them. To put the animal in the correct place, children have to identify the shape of the entrance. Each element also has a plexiglass window and it is marked with a number.

- 6 tower pieces
- 6 animal figurines: hedgehog, owl, zebra, hare, crocodile, cat
- dim.: of the biggest piece: 12 x 12 x 12 cm,
dim. of the smallest piece: 5 x 5 x 5 cm,
height of the tower: 51,5 cm
- material: wood, plexiglass
- age: 12 m+





CONSTRUCTION TOYS



**Set of transparent colour bricks
ST2010**

- 58 pcs.; dim. of the set: 40 x 5 x 31 cm
- dim. of the smallest brick: 3,1 x 3,1 x 5,6 cm
- material: transparent plastic; transparent bag with a handle
- age: 18 months+



**Neopuzzle mega classroom set.
Magnetic bricks
NS4307**

- 120 pcs.
- includes platforms with wheels for vehicle construction
- material: plastic, magnet; age: 3+

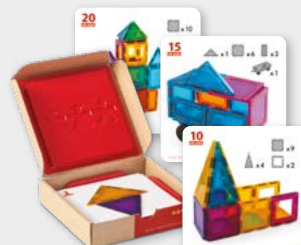

**Neopuzzle magnetic bricks
worksheets - mega classroom set
NS4307W**

- 24 pcs.; dim of the worksheet: 23 x 11 cm
- material: foiled cardboard
- a cardboard box with a plastic blister; age: 3+



**Neopuzzle windows.
Magnetic bricks
NS4308**

- 62 pcs.
- material: plastic, magnet
- age: 3+



**Neopuzzle magnetic bricks
worksheets - windows
NS4308W**

- 24 pcs.; dim of the worksheet: 23 cm x 11 cm
- material: foiled cardboard
- a cardboard box with a plastic blister; age: 3+



**Sensory pop tubes
NS4115**

- 60 pieces in 6 colours (red, yellow, blue, green, orange, purple); dim.: length without stretching: 14 cm, diam.: 1,9 cm; material: plastic; age: 3+

**Pop tubes worksheets
NS4115W**

- 24 pcs.; dim of the worksheet: 23 x 11 cm
- material: foiled cardboard
- a cardboard box with a plastic blister; age: 3+



**Neopuzzle full shapes.
Magnetic bricks
NS4306**

- 49 pcs.
- includes platforms with wheels for vehicle construction
- material: plastic, magnet; age: 3+



**Neopuzzle magnetic bricks
worksheets - full shapes
NS4306W**

- 24 pcs.; dim of the worksheet: 23 x 11 cm
- material: foiled cardboard
- a cardboard box with a plastic blister; age: 3+

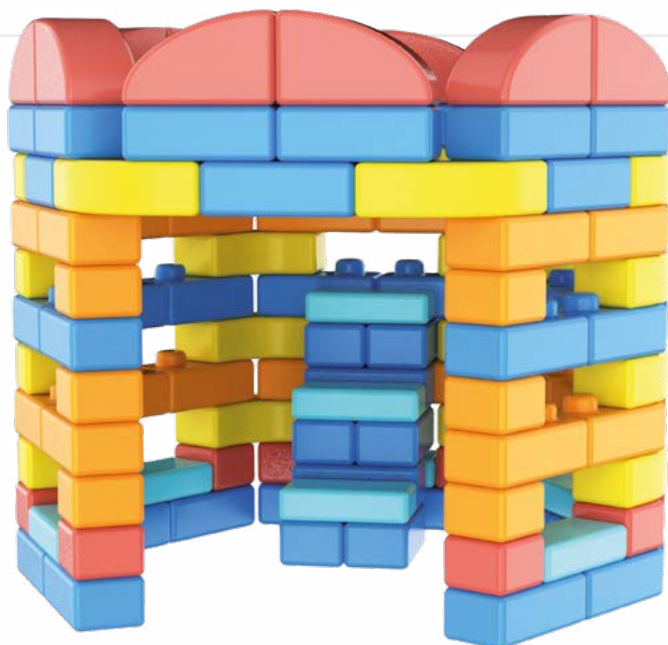

Giga blocks NS4116

Big, light, hollow blocks for building impressive constructions.

- 180 pcs. in 5 shapes:
dim. of the cube: 10 x 10 x 9 cm,
dim. of the cuboid: 20 x 20 x 9 cm,
dim. of the arch: 26,5 x 14 x 9 cm,
dim. of the wedge: 20 x 10 x 12 cm
- material: plastic
- age: 3+

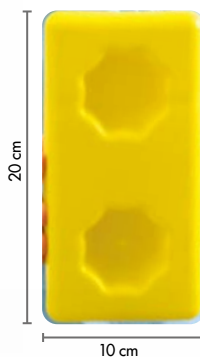

Tangram foam puzzle NS2096

Soft, colourful foam elements on a foam base. The elements can be arranged into a pattern on the base or outside of it. The second option will allow children to be more creative by creating their own patterns and shapes.

- Foam base
- 7 foam shapes
- dim.: 38 x 38 cm
- age: 1+

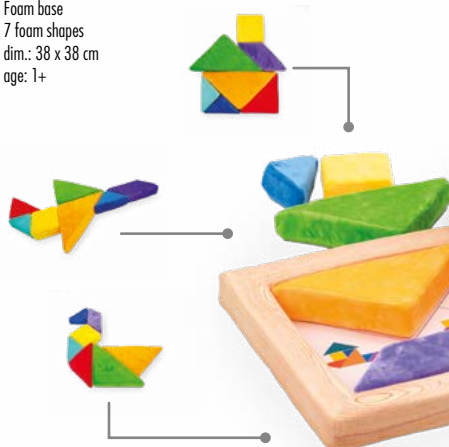

Vehicle. Large wafer blocks BY5011

A set of large waffle blocks with a platform on wheels. From the blocks you can build a vehicle for transporting toys.

- 12 elements: 7 squares of 22 x 22 cm,
- 4 triangles of 22 x 23 cm; platform of 49 x 7 x 36 cm
- dim. of the vehicle after folding 49 x 40 x 36 cm
- length of string: of 78 cm; foil bag with handle; material: plastic
- random colours of elements; age: 3+



CONSTRUCTION BRICKS

K'nex construction blocks

Sets of building blocks that allow to create detailed models of vehicles, bridges, buildings and machines. The high quality of the material and attention to detail makes the blocks perfectly fitted. Children will learn the laws of physics on the models they build. The basic sets are designed for children as young as 5 years old, with detailed pictorial instructions to map out each step. More detailed kits, consisting of more complex elements, are designed for older, experienced engineers. With the ability to create 3D constructions, children learn spatial thinking and train manual dexterity. When creating structures according to instructions, they learn accuracy, and by building non-schematic structures, they develop imagination and the ability to think outside the box.



Fun constructions KX0202

- 300 pcs
- 20 models to build
- container for storing blocks; age: 7+



Simple vehicles KX0206

- 125 pcs
- 10 models to build
- age: 7+



Tires and wings KX0208

- 500 pcs.
- 30 models to build
- age: 7+

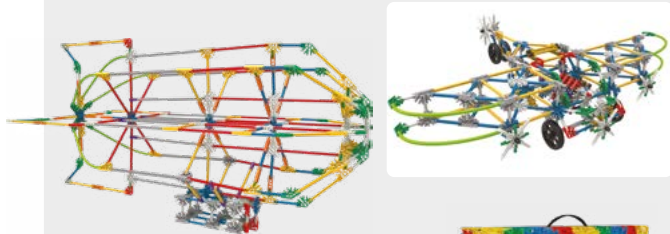

**100 models
KX2605**

- 863 pcs.
- 100 models to build
- age: 7+



**Set for beginners
KX5210**

- 141 pcs.
- 40 models to build
- age: 5+

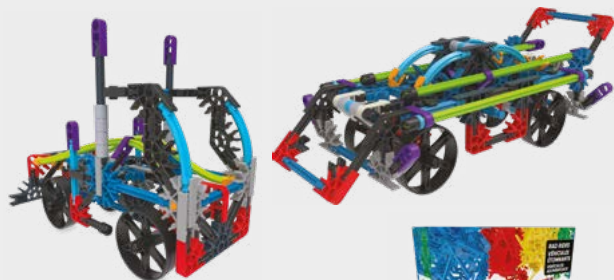

**Vehicles on wheels
KX5214**

- 206 pcs.
- 12 models to build
- age: 7+

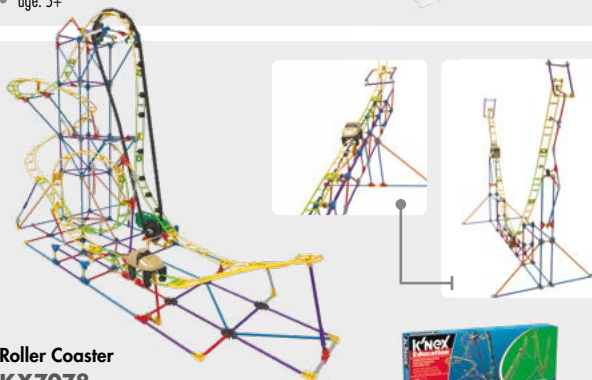

**Roller Coaster
KX7078**

- 546 pcs.; battery-powered drive motor
- 3 worksheets with experiments
- 2 x AA type battery included; age: 8+



**Levers and pulleys
KX8610**

- 178 pcs.
- 7 models to build
- age: 8+



**Great constructions
KX8020**

- 700 pcs.
- 40 large models to build
- age: 7+



OUTDOOR EQUIPMENT

Wooden play time corners are designed especially for the outdoor use. The pieces made of natural, preserved and varnished Finnish pine are robust and resistant to different weather conditions such as rain, moisture and sunlight. Play corners allow children to spend the time outside in a creative and stimulating way. The opportunity

to experiment with natural materials such as sand, water, grass, pinecones and sticks has a positive effect on the development of sensory integration, especially when enriched by the use of included accessories. In addition, long and frequent exposure to the outdoors provides the body with oxygen, increases the immunity and promotes better development.

Wooden sensory table - outdoor play

CI0011

A wooden table with 6 bowls for outdoors and sensory play. Each of the 3 pairs of bowls is different. The first one is shiny and reflective, the second pair is mat, and the third pair has a perforation, which allows it to function as a strainer. It is possible to take out the bowls for transportation or cleaning.

- dim.: diam.: 90 cm, height: 60 cm
- material: wood, metal
- age: 3+



Wooden kitchen sink - outdoor play

CI0013

A playset with simple plumbing and a sink. The pump can make water flow from the tap, which then flows into a container on the bottom shelf. The sink can be used for sensory play, to wash hands after playing outside or to clean up after an outdoor picnic.

- dim. of the set: 70 x 50 x 103 cm
- material: impregnated and varnished Finnish pine
- 1 x stainless steel sink, dim.: 37 x 31 x 15 cm
- 1 x cooking pot with two handles, dim.: 15,5 x 5,5 cm, made of stainless steel
- 1 x pan, dim.: 22,5 x 13,6 x 4,5 cm, made of stainless steel
- 1 x ladle, dim.: 5,5 x 2,8 x 19 cm, made of stainless steel
- 1 x skimmer spoon, dim.: 45 x 50 x 161 cm, made of stainless steel
- plastic water container which can hold 50 l of water, dim.: 48 x 35,4 x 25,8 cm; age: 3+



Wooden kitchen - outdoor play

CI4587

Kitchen playset with a worktop and a sink. The toy oven has got a chalkboard on its door. Two rolling pins make sounds when in use. Canopy protects from the sun.

- dim. of the set: 100 x 48 x 136 cm
- material: impregnated and varnished Finnish pine
- 1 x cooking pot with two handles, dim.: 15,5 x 5,5 cm, made of stainless steel
- 1 x pan, dim.: 22,5 x 13,6 x 4,5 cm, made of stainless steel
- 1 x ladle, dim.: 5,5 x 2,8 x 19 cm, made of stainless steel
- 1 x skimmer spoon, dim.: 45 x 50 x 161 cm, made of stainless steel
- 1 x big stainless steel bowl; 2 x small stainless steel bowl; age: 3+





Musical workshop - outdoor play

CI0163

This musical playset centres on playing musical instruments and creating music collectively. It could be valuable in music therapy sessions and when working with children who have special educational needs. It is easily accessible from all sides and the size of instruments encourages physical activity. on fresh air. The possibility to install the playset outside, allows for active, musical play in the open air.

- dim. of the set: 130 x 120 x 165 cm
- material: impregnated and varnished Finnish pine
- 25 x iron wind chime with a metallic sound
- 1 x bells with 13 synthetic fibre plates
- 8 x iron bell with a button
- 8 x musical tubes
- 2 x hanging iron percussion instrument
- 2 x percussion stick
- age: 3+



Wooden watermil - outdoor play

CI0087

With the use of two funnels, you can pour water into the mil and observe the wheel turning. Depending on which funnels you choose, the wheel will rotate clockwise or counterclockwise.

- dim.: 38 x 44 x 65 cm
- material: wood, plastic
- age: 3+



Bakery playhouse

NS4114

A little bakery with a counter, an entrance with a curtain and a fabric roof. However, this playhouse can also be transformed into a shop, a post office or a confectionery at any moment.

- dim.: 98 x 92 x 115 cm
- material: plastic, fabric
- age: 3+

ANIMALS



Reptiles - animal figurines

MJ0013

- monitor lizard, chameleon, alligator, giant tortoise, rattlesnake, tree frog;
- dim.: monitor lizard length: 15 cm, chameleon length: 10,5 cm, alligator length: 20 cm, giant tortoise length: 8 cm, rattlesnake length: 7 cm, tree frog length: 5 cm
- material: plastic
- age: 3+



Farm. Enclosure for animal figurines MJ0014

Thanks to this set you will be able to recreate a realistic animal run with railings, fences, a trough and food.

- 2 x railing, 7 x food elements, 9 x fence elements, 1 x gateway
- dim. when assembled: 56 x 50 x 11 cm
- horse figurine available separately
- material: plastic
- age: 3+

SPINNING TOPS



Unicorn merry-go-round FT5958

When pushed at the top, the unicorns spin around and move up and down.

- dim.: 17 x 17 x 22 cm
- material: plastic
- age: 6 months +



BUBBLE

Lawnmower - bubble generator 2in1 TU2956

A lawnmower with a liquid container. When pushed, it generates dozens of bubbles.

- dim.: 27 x 25 x 51 cm
- material: plastic
- age: 6+





Elephant on wheels
ST2007

- dim.: 17,5 x 6 x 15,8 cm
- material: foam material, plastic
- age: 0+



Dragon on wheels
ST2008

- dim.: 17,7 x 6 x 16,5 cm
- material: foam material, plastic
- age: 0+



Crocodile on wheels
ST2009

- dim.: 17,9 x 6 x 12,6 cm
- material: foam material, plastic
- age: 0+



Eco trucks - set of bricks
ST2011

- 120 pcs.
- dim. of the smallest brick: 3,1 x 3,1 x 5,6 cm
- material: plastic made in 25% of rice flour
- set of stickers
- age: 18 months +



MAGNETIC AIDS



Magnetic horseshoe
JN0039

- 1 pc.; convenient, big handle
- dim.: 12 x 12 x 2 cm
- colour selected at random
- age: 18 months+



Magnetic wand
JN3800

- 1 pc.
- dim.: 20 x 3 x 1,5 cm
- age: 18 months+

MATHS



Dice in dice - set of 6 JN1120

The dice can be used during games or for arithmetic operations. More advanced students can use it for learning probability when predicting outcomes and performing statistical calculations. Outer dices in 6 colours are transparent while the inner dices are white. Each dice has a print of numbers from 1 to 6.

- 6 pcs. dices in 6 colours with smaller dices inside
- dim.: 4 x 4 x 4 cm
- material: plastic; age: 3+

Dinosaurs - sorting set UT0061

A set of transparent boxes in 6 colours and in 6 shapes to which you can assign the dinosaurs by colour. The figurines are placed in the boxes with the use of tweezers included in the set. This activity teaches to recognise shapes, colours and common traits as well as it promotes the development of dexterity, precision, coordination and patience.

- 6 transparent boxes in 6 colours and shapes with lids
- 6 sets of dinosaurs figurines in colours matching the boxes
- material: plastic; age: 3+



Engineering vehicles - counting aids TY1021

- 40 pcs.: 8 types in 5 colours; dim. 1 pc.: height: 2,5 cm
- material: thermoplastic caoutchouc; age: 3+

AUDIOVISUAL EQUIPMENT

Softbox with 30W bulb on lighting stand HG0050

Softbox:

- dim.: 50 x 70 cm, material: nylon reflective fabric, resistant to high temperatures, leveling shadows of objects

Tripod on tripod:

- height adjustment: from 54 cm to 2 m, lighting angle adjustment, material: aluminum

Bulb:

- power: 30 W, colour temperature: 5700K, colour rendering index: 90
- bag included



Sound system set HG0053

- 1 x 12-inch Class D bass-reflex speaker
- output power: (RMS/peak): 800 W/3200 W
- frequency range: 50 Hz – 20 kHz
- max SPL (peak): 127 dB
- protection: multi-band DSP plus limiter, overcurrent and thermal protection
- subwoofer connectors: 2 x XLR/6.35 mm combo line inputs, XLR/6.35 mm combo microphone input, XLR system output
- line input: 2 x combo XLR/6.3 mm Jack
- microphone input: 2 x XLR/6.3 mm combo jack
- 2 speakers with wooden column (1 x 6.5" woofer, 1x1" tweeter)
- 2 speaker cables with a length of 3 m
- tripod height: 650–1400 mm
- materials: subwoofer: 15 mm plywood, column: aluminum
- dim.: subwoofer: 400 x 515 x 525 mm, column 2 pcs: 520 x 520 x 390 mm
- weight: columns (2 pcs.): 9.2 kg, subwoofer: 23 kg





3D PENS

Suitcase with 3D pens and accessories is a comprehensive set dedicated to STEAM classes which provides practical tools for the creative use of 3D technology. The method of 3D printing with pens consists of heating the filament (thermoplastic material) and putting it onto a surface to draw or create shapes layer by layer to achieve spatial artworks. 3D pens are functional and safe aids for the first contact with this printing technology to develop students' technical competence and expand their spatial imagination. The suitcase made of plastic effectively protects the contents from impact when in move. It is an inspiring set which encourages experimenting and develops 3D printing skills.



Suitcase set of 3D pens and Power Banks NS9210

The set includes:

- 6 3D pens with filaments and stands
- 6 power banks - 10000 mAh
- templates book facilitating the creation of different projects

Suitcase for 3D pens and Power Banks NS9247

- a storage space for 6 Power Banks and 6 3D pens
- foam filling



16 channel sound mixer HG0054

- 8/12/16 channels
- 3-band equalizer; 4 mono + 4 stereo channels and with 2AUX "return" and "send"
- 7-band stereo graphic equalizer with feedback
- USB input; LCD screen
- +48 V phantom power supply

Directional microphone with accessories HG0051

The condenser microphone supports a wide frequency band. It is designed for use with mobile devices, cameras, recorders, computers, laptops and recorders.

- material: lightweight aluminum construction
- power supply from the recording device
- sensitivity [dB]: - 42; frequency response [Hz]: 18 000
- power supply: mini-jack 3.5mm



Wireless microphone set HG0055

- 4 x wireless handheld microphone
- UHF band
 - bandwidth: 610–690 MHz
 - range: up to 50 m



mail
export@nowaszkoła.com



address
POW 25,
90248 Łódź - Poland



telephone
+48 42 639 97 37



internet
www.nowaszkoła.com



Export Catalogue 2023

nowa szkoła

