



Explore the world of **JollyHeap** step by step

"The magical power of attraction"
JollyHeap



From fun to JollyHeap

The **JollyHeap** company was born out of innocent play with couch cushions. Ingenious in its simplicity, the idea to hold the structure with magnets became the origin of **JollyHeap** magnetic construction blocks, which today are sold nationally and internationally.

The Polish brand was founded in 2015 by Svitlana and Oleksandr Sapunovych, the originators and producers of the world's first large textile magnetic blocks, which visualise children's dreams of playing as if in another dimension.

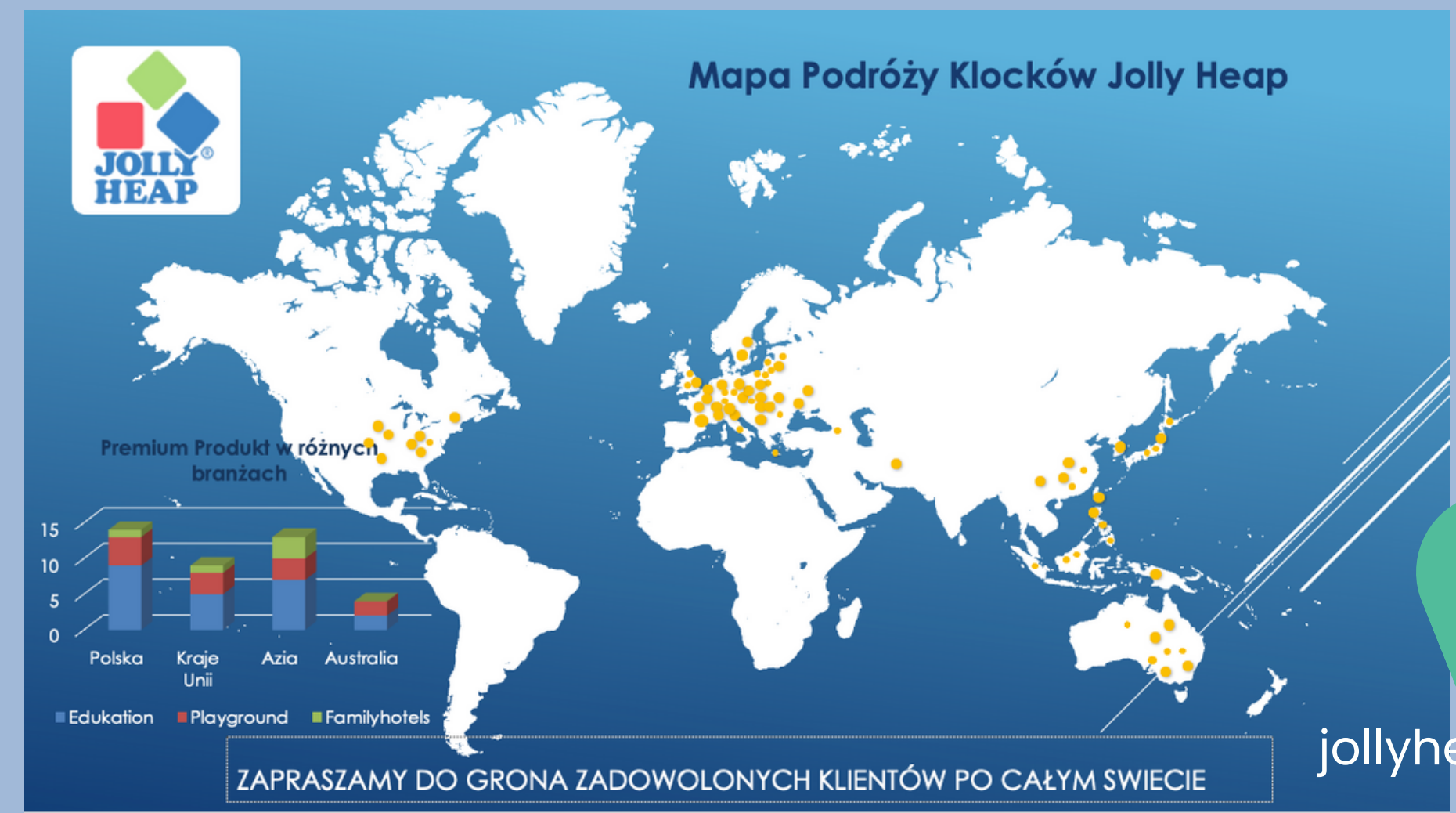



Reservation of the word and figurative trade mark

The JollyHeap trade mark and the name JollyHeap have a word and figurative patent in Poland, Europe and the world.

Digitally Signed by United States Patent and Trademark Office
Location: United States Patent and Trademark Office
Date: 2022.05.24 09:00:31 -0400

United States of America
United States Patent and Trademark Office

JollyHeap

Reg. No. 6,733,701
Registered May 24, 2022
Int. Cl.: 28, 35
Service Mark
Trademark
Principal Register

JollyHeap Svitlana Sapunova (POLAND SOLE PROPRIETORSHIP)
ul. Mikolaja Reja 15, Smardzów
PL-55-010 Swieta Katarzyna
POLAND

CLASS 28: Toys, namely, building blocks; toys adapted for educational purposes, namely, children's educational toys for developing fine motor, cognitive, and counting skills; toys sold in kit form comprised of toy building blocks and interlocking construction toys; toy building blocks made of fabric; wooden toy building blocks; interlocking toy construction pieces; toy building blocks; toy building blocks capable of interconnection; plug-in toy construction bricks; mascot dolls; puzzles in the form of geometric solids; multi-part construction toys; toy sets comprised of toy building blocks and interlocking construction toys; toy building block sets; play shops in the nature of play houses

CLASS 35: Retail store services in the field of toys; wholesale store services in the field of toys; administrative processing of purchase orders within the framework of services provided by mail order companies; computerized on-line ordering services in the field of toys; providing consumer product advice relating to toys; retail and wholesale store services featuring toys adapted for educational purposes; toys sold in kit form; toy building blocks of wood; interlocking toy construction pieces; toy building blocks; toy building blocks; interconnectable, plug-in toy bricks; mascot dolls; cube puzzles; multi-part construction toys; toy sets; toy building block sets; online retail and wholesale store services featuring toys

THE MARK CONSISTS OF STANDARD CHARACTERS WITHOUT CLAIM TO ANY PARTICULAR FONT STYLE, SIZE OR COLOR

OWNER OF INTERNATIONAL REGISTRATION 1574320 DATED 12-09-2020, EXPIRES 12-09-2030

SER. NO. 79-303,747, FILED 12-09-2020

Katherine Kelly Vidal
Director of the United States Patent and Trademark Office

Innovation, Sciences et Développement économique Canada
Office de la propriété intellectuelle du Canada

Innovation, Science and Economic Development Canada
Canadian Intellectual Property Office

29 dec/Dec 2022
Date/Reference: Your File

Notation: Our File
2153166
Numero #: IP Number
1614190

JollyHeap Svitlana Sapunova
Aleja Lot 4
PL-55-020 Rzeszlin
POLAND

RE: Trademark: JOLLY HEAP
Applicant: JollyHeap Svitlana Sapunova

This examiner's report concerns the above identified Protocol application. To avoid abandonment proceedings, a proper response must be received by this office by June 29, 2023. All correspondence respecting this Protocol application must indicate the file number.

This Protocol application has been examined under the provisions of the *Trademarks Act* and *Trademarks Regulations*.

In compliance with paragraph 31(1) of the *Trademarks Regulations*, the applicant is required to provide a statement that colour is claimed as a feature of the trademark, along with the name of each colour claimed and an indication of the principal parts of the trademark that are in that colour.

What constitutes the "principal parts" of a particular trademark will depend on the complexity of the trademark. However, in general, the subject Protocol application need only describe the readily-identifiable elements of a trademark that appear in each colour. For example, if a trademark contained a forest scene, an acceptable colour claim might be:

Colour is claimed as a feature of the trademark. The sky is blue, the grass is green, the tree trunks are brown and the leaves are red, orange, and yellow.

For further guidance on colour description, please see Section 2.4.3.8 of the *Trademarks Examination Manual* available on the CIPO website.

In addition, pursuant to paragraph 30(2)(a) of the *Trademarks Act*, an application for the registration of a trademark must contain a statement in ordinary commercial terms of the associated goods or services. Furthermore, section 29 of the *Trademarks Regulations* requires that the statement must describe each of those goods or services in a manner that identifies a specific good or service. It is considered that the following goods and services are not in specific and ordinary commercial terms:

- 1) [...], apparatus and accessories for physiotherapy, exercise therapy and rehabilitation; mattresses, pads [...] for medical purposes (Class 10)
- 2) Furniture; furniture, for office use, of metal, for school use; seats; non-metal furniture fittings; items of furniture; mobile decorations of wood, wax, plaster, plastic; baskets, non-metallic (Class 20)

50, rue Victoria • Place du Portage 1 • Gatineau (Québec) K1A 0C9 • www.opic.ic.gc.ca
50 Victoria Street • Place du Portage 1 • Gatineau, Quebec K1A 0C9 • www.cipo.ic.gc.ca

Canada

Australian Government
IP Australia

22 September 2021

International Bureau, WIPO
34, chemin des Colombettes
P.O. Box 18
1211 Geneva 20,
SWITZERLAND

International registration number: 1600316
Australian Trade mark Number: 2191343
Holder's name: JollyHeap Svitlana Sapunova

Madrid Protocol
Final Disposition on Status of a Mark
Statement of Total Grant of Protection
Rule 18ter(1) of the Common Regulations

The trade mark has been protected in Australia on 22 September 2021.

Please note, that under the requirements of the *Australian Trade Mark Regulations 1995* the holder of the trade mark is required to notify the Registrar, in writing, of the holder's address for service in Australia or New Zealand, as soon as practicable after receiving the statement of protection.

Sincerely,
IP Australia

Page 1 of 3

第 52558705 号

商标注册证

核定使用商品/服务项目 (国际分类: 35)
第 35 类: 通过邮购定单进行的广告宣传; 货物展出; 进出口代理; 市场营销; 广告; 商业建议; 提供商业和商务联系信息; 为消费者提供商品和服务选择方面的商业信息和建设; 提供商品销售信息; 对购买定单进行行政处理 (截止)

注册人 欢乐堆斯维特拉娜萨普诺娃公司
"JOLLY-HEAP" Svitlana Sapunova

注册人地址 波兰圣凯瑟琳市斯马尔佐夫县米科拉杰伊街15号, 邮编55-010
Ul.Mikolaja Reja 15, Smardzow 55-010 Swieta Katarzyna POLONIA

注册日期 2022年04月14日 有效期至 2032年04月13日

局长 申尔雨 发证机关

EUROPEAN UNION DESIGN REGISTRATION

This registration guarantees
protection in 28 member states,
including Poland.



CUSTOMER SERVICES DEPARTMENT
D113D

Copia Certificada • Beglaubigte Abschrift • Certified Copy
Copie Certifiée • Copia Autenticata

Por el presente se certifica que el documento que se adjunta es una copia conforme del certificado de registro para el dibujo o modelo comunitario cuyo número y fecha de registro aparecen a continuación.

Hiermit wird bestätigt, dass die Abschrift, die diesem Beleg beigeheftet ist, eine genaue Abschrift der Eintragungsurkunde ist, die für das Gemeinschaftsgeschmacksmuster mit der nachstehenden Eintragsnummer und dem nachstehenden Eintragungstag ausgestellt wurde.

This is to certify that the attached document is an exact copy of the certificate of registration issued for the registered Community design bearing the registration number and date indicated below.

Par la présente, il est certifié que le document annexé est une copie conforme du certificat d'enregistrement délivré pour le dessin ou modèle communautaire portant le numéro et la date d'enregistrement qui figurent ci-après.

Con la presente si certifica che l'allegato documento è una copia conforme del certificato di registrazione per il disegno o modello comunitario contrassegnato dal numero e dalla data di registrazione riportati sotto.

Núm./Nr./No/n°/n.	Fecha/Datum/Date/Date/Data
003482140-0001	25/11/2016

Alicante, 07/12/2016

Birgit Filtenborg

Birgit Filtenborg

Departamento de Servicios al Cliente
Hauptabteilung Kundendienstleistungen
Customer Services Department
Département «Services aux Clients»
Dipartimento Servizi ai Clienti



Magnetic blocks JollyHeap

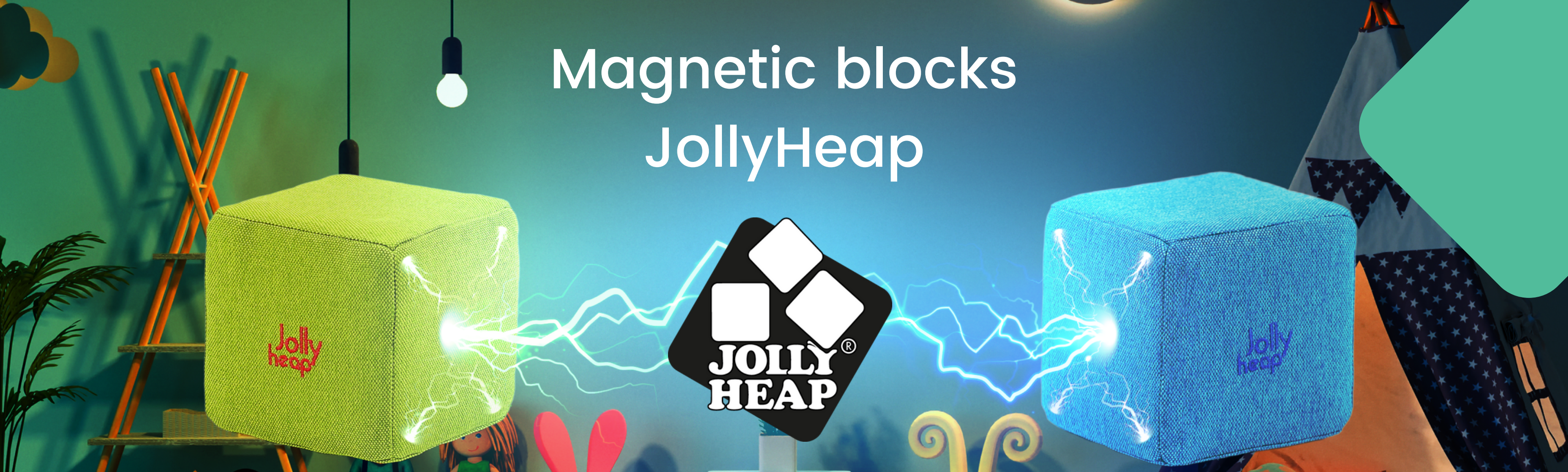

Four Types of Shapes

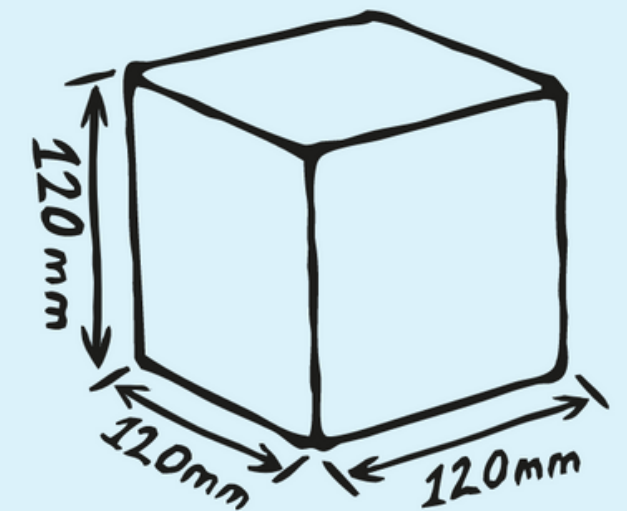
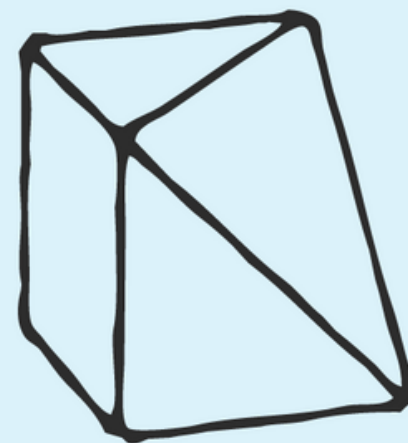
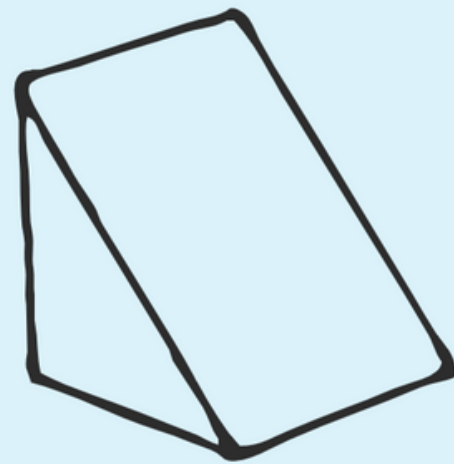
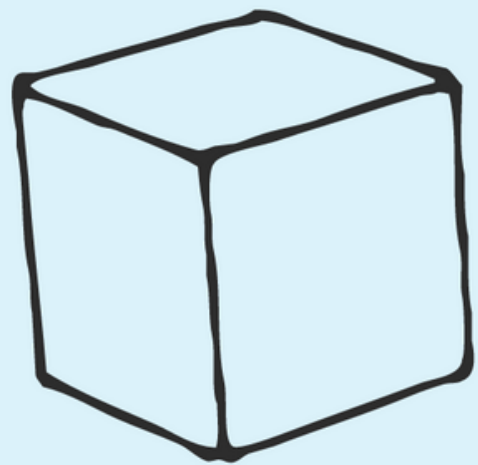



Colour variants

36 combinations

Colours to suit international tastes and cultures, there is something for everyone.

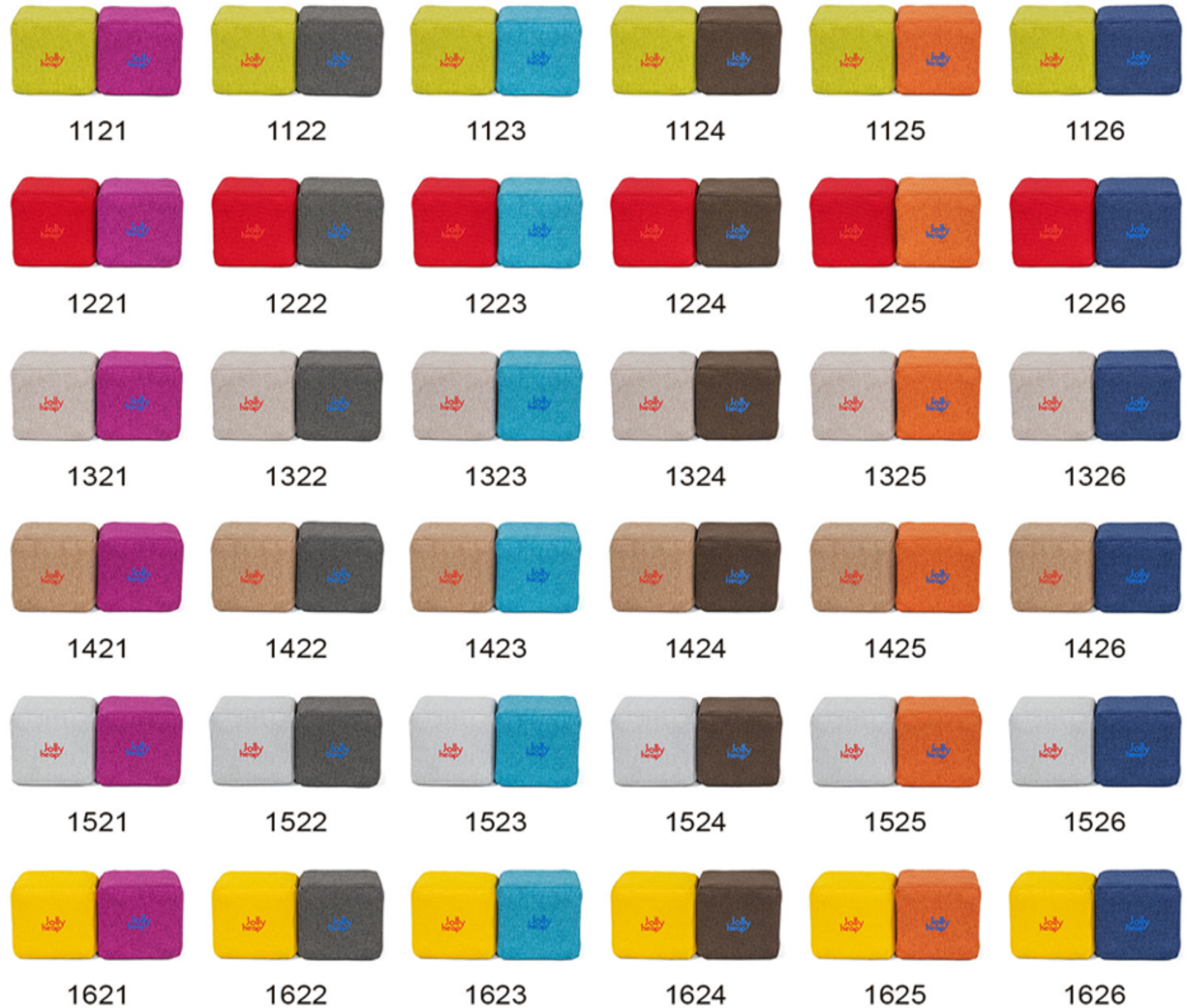



Product specification

JollyHeap magnetic construction blocks components

Soft



Weight: 150g

Rounded edges

4 shapes



Durable fabric:
00% PES

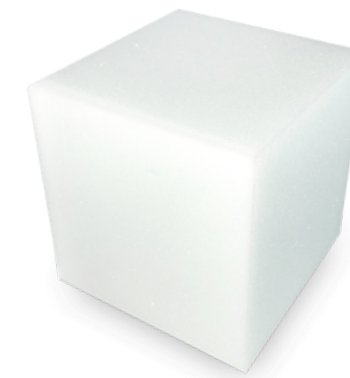

Polyurethane
foam



Neodymium
magnets

The magnets in the construction blocks are attracted to each other according to their polarity (+/-), which is determined by the colours of our blocks, so **the sets are always composed of 2-coloured blocks!**

JollyHeap is the first soft construction blocks in the world that can be connected to each other from all sides.



jollyheap.com



Fabric specification

Safe | **Durable** | **Easy to clean**

The fabric used in **JollyHeap** blocks is selected, tested and the best for this type of product.

Over the years, we have tested many types and grades of textile, but the final one, from which our blocks are sewn, is the most:

- **durable,**
- **safe,**
- **strong,**
- **and flexible,**

for this type of product and purpose. It best meets all user requirements.

Fabric: 100% PES
Weight: **310 g/m² +/- 5%**

 Tensile Strength

 Test Martindale
Abrasion resistance

 Tear growth resistance

 Colour fastness to light

 Fastness to rubbing dry

 Fastness to rubbing wet

 Fire Protection



 **EASY
TO
CLEAN**



OEKO-TEX®
CONFIDENCE IN TEXTILES
STANDARD 100 



jollyheap.com



THREAD



Thread specifications

The threads connect and at the same time lock all the components of the **JollyHeap** construction blocks together, which is why their quality is so important to us.

The threads used in the **JollyHeap** blocks are reinforced and made **from 100% PES fibres**, which are characterised by:

- high tensile strength,
- low stretch,
- excellent sewing properties,
- high raw material quality,
- **high resistance to abrasion, light and chemical agents.**

 100% PES



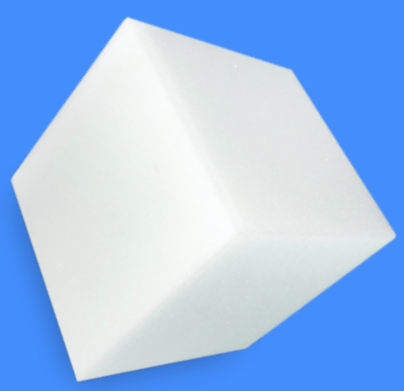
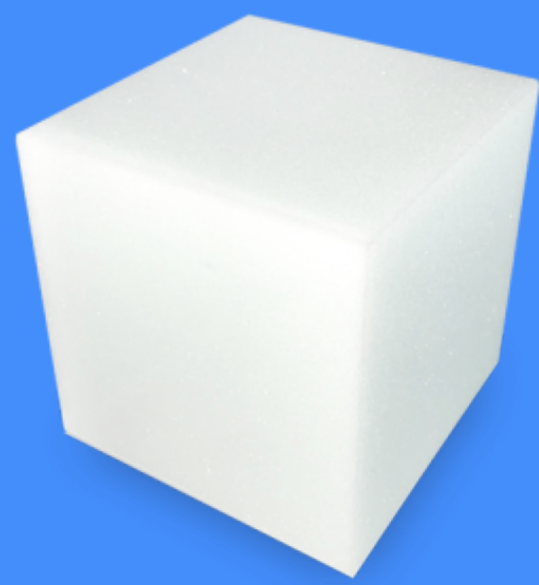
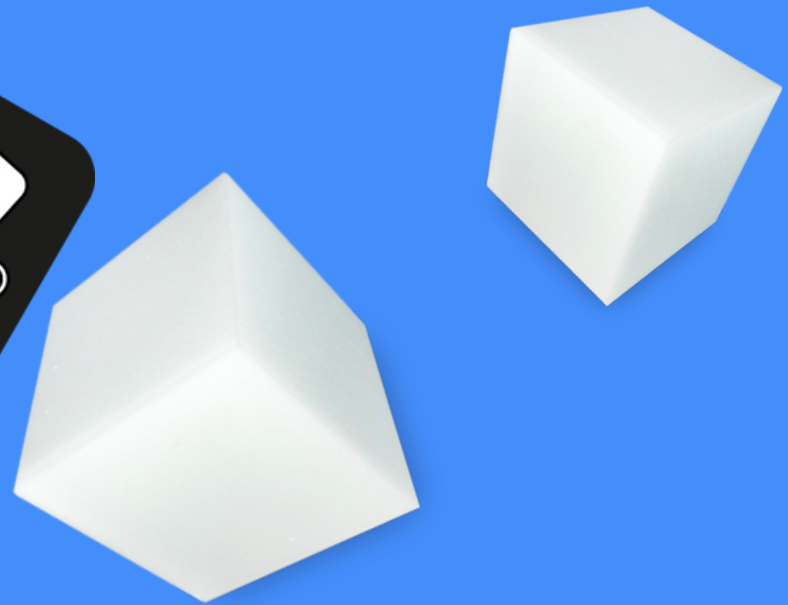
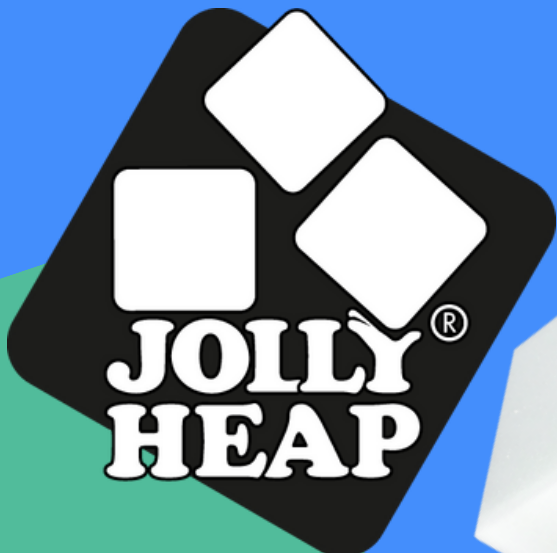

FOAM

Foam specification



The foam used in the **JollyHeap** construction blocks is polyurethane foam - extremely strong, multifunctional and suitably dense.



This foam plays a key role in our construction blocks. It is what makes them:

- **resilient,**
- **strong**
- **and non-deformable.**

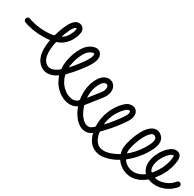

Its **basic and most important parameter** is its **density and rebound** property. It has the ability to return to its form after repeated compression.



Magnet specification

The magnets placed in **JollyHeap** construction blocks are some of the most durable magnets in the world: **neodymium magnets**.

Their innovative composition:

- **neodymium,**
- **boron**
- **and iron,**

these three components were enough to obtain a type of magnet that produces a very strong magnetic field. This, in turn, gives it an enormous attraction force.

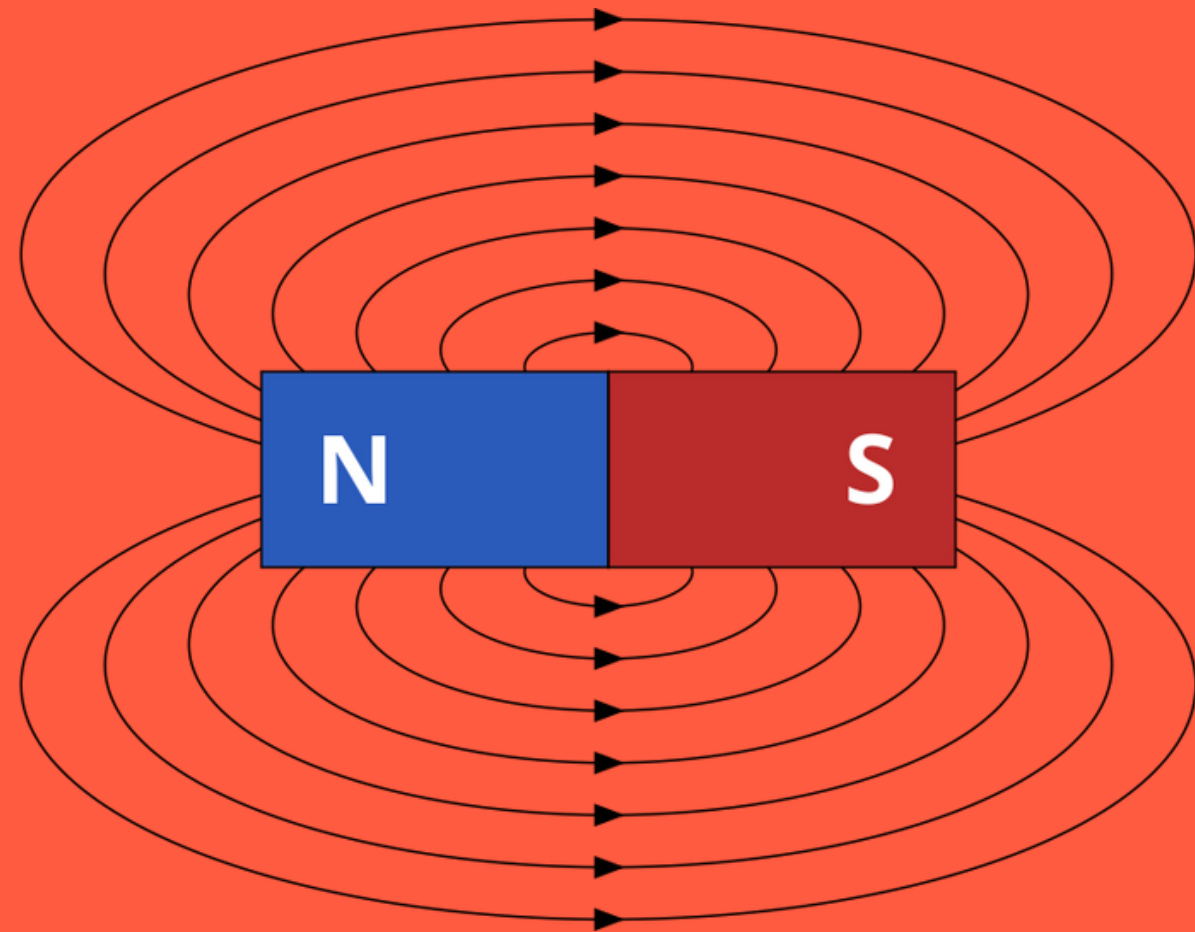

Neodymium magnets

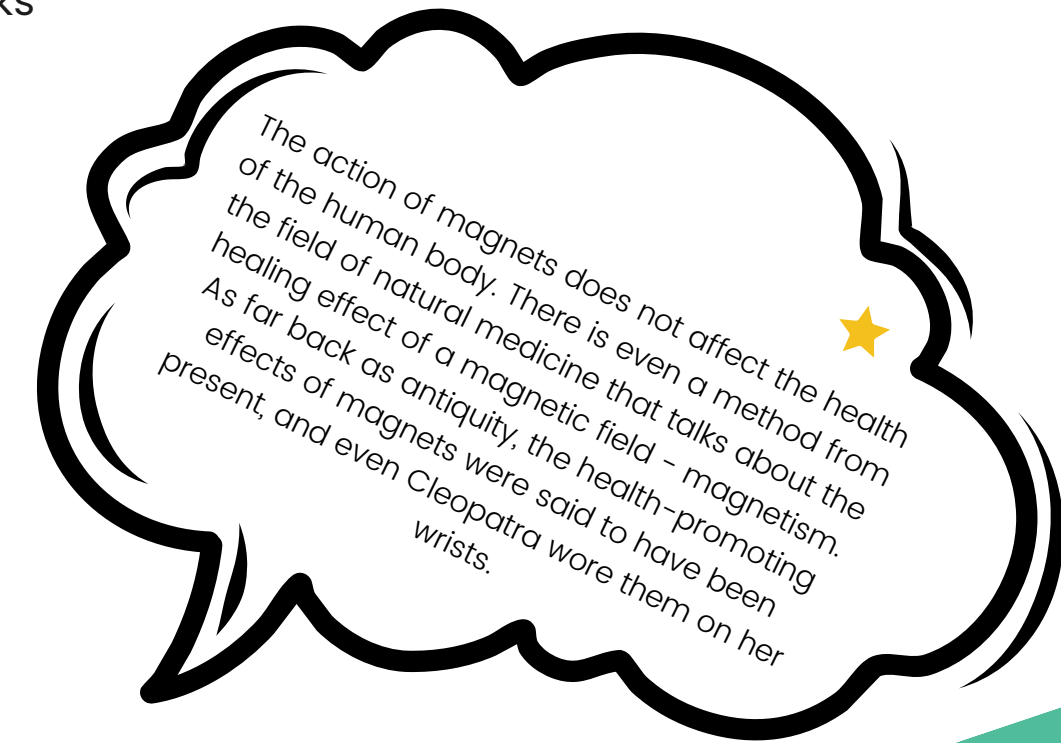

Characteristics:

- Neodymium magnets are permanent magnets. This means that they **do not lose their properties over time,**
- Above all, they produce **the strongest magnetic field of all magnets known today,**
- They are resistant to the effects of heat,
- **And do not rust**

*They are produced by using the powder metallurgy method. It involves the pressing of powdered components at a high temperature and in a strong magnetic field. The production process ends with a nickel coating of the magnet.



Branding

On each construction block there is an **embroidered JollyHeap logo**, the colour of which shows the polarity of the block.

RED +
BLUE -



Easy cleaning in the washing machine!



Care Cleaning



Instruction:

- To keep the construction blocks clean, they should be vacuumed regularly, preferably with a Hoover.
- After vacuuming, wipe them on all sides with a damp (not wet!) cloth.
- The blocks can be washed in a washing machine with no more than 6-9 pieces of the same colour.
- Wash using a short washing programme at 30°C.
- Dry the blocks at room temperature.

✗ Do not tumble dry

✗ Do not iron

✗ Do not dry on hot surfaces

✗ Do not dry in the sun

✗ Do not bleach





KOMAG certification

Inspection and certification

JollyHeap magnetic construction blocks comply with the requirements of Directive 2009/48/EC of the European Parliament and of the Council on toy safety, by meeting the relevant requirements of the standards: PN-EN 71-1, PN-EN 71-2, PN-EN 71-3. - PN-EN 71-1 Safety of Toys.

Part 1. Mechanical and physical properties

- PN-EN 71-2 Safety of Toys.

Part 2. flammability

- PN-EN 71-3:2014-12 Safety of Toys.

Part 3. Migration of certain elements

- Regulation (EC) No 1907/2006 of the European Parliament and of the Council of 18.12.2006. - REACH (OJ L 396, 30.12.2006, p.1-794, as amended) for phthalates, cadmium and primary aromatic amines.

Notified Body No. 1456



EC-TYPE EXAMINATION CERTIFICATE

- [1] 
- [2] Directive 2009/48/EC of the European Parliament and of the Council on toys safety.
- [3] EC-type examination certificate No.: **KOMAG 22TOYS0020**
- [4] Toy's name: **"JollyHeap" Magnetic Blocks**
- [5] Manufacturer: **"JollyHeap" Svitlana Sapunova**
- [6] Address: **Mikołaja Reja 15, 55 – 010 Smardzów Siechnice, Poland**
- [7] The toy together with its approved versions is described in the enclosure to this certificate as well as in documentation cited in it.
- [8] KOMAG Institute of Mining Technology, Division of Attestation Tests, Certifying Body No. 1456 according to the article 26 of Directive 2009/48/EC of 18 June 2009 confirms that the toy, which is the subject of this certificate meets the essential health and safety requirements for toys mentioned in Annex II of Directive 2009/48/EC.
Results of the assessment and testing are given in the confidential Report No. **RO – 20/W/2022**
- [9] Essential health and safety requirements were satisfied by meeting the relevant requirements of the following standards:
PN-EN 71-1+A1:2018-08, PN-EN 71-2:2021-05, PN-EN 71-3+A1:2021-09
- [10] This EC-type examination certificate concerns the technical design of the toy and the assessment of samples, representative of the production envisaged, according to Directive 2009/48/EC.
The certificate does not cover the other requirements of the Directive concerning the production process and placing on the market of the toy.



Certificate is valid from **20 January 2022 to 19 January 2027.**



Head of Division of Attestation Tests
Certifying Body

Andrzej Figiel, Ph.D. Eng.



JollyHeap construction blocks

- **ENTERTAIN** at home, nursery, school, playground.
- **EXCERCISE** in corrective, sensory and physiotherapy lessons.
- **DEVELOP** fine and gross motor skills.
- **TEACH** through constructional thinking and creativity.
- **INTEGRATE** through playing together, getting to know each other better.

***Age: 1-99, for every construction block lover.**



We work together

Education



Entertainment



Hotels
Restaurants

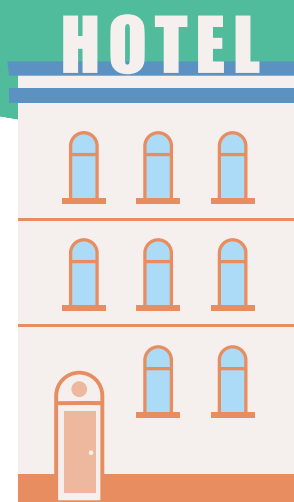

Physiotherapy



Travel
agencies



Event
companies





Offer for partners

Kits available:



Set name

Medium 50/2
50 pcs.

Basic 100/2
100 pcs.

Creative 100/4
100 pcs.

JOY 150/2
150 pcs.

Material

100% PES, polyurethane foam, 1050 pcs. neodymium magnets

100% PES, polyurethane foam, 2100 pcs. neodymium magnets

100% PES, polyurethane foam, 2196 pcs. neodymium magnets

100% PES, polyurethane foam, 3150 pcs. neodymium magnets

Model

22 shapes: cube, triangle

2 shapes: cube, triangle

4 shapes: cube, triangle, truncated cube, pyramid

2 shapes: cube, triangle

Weight of 1 block

150 g

150 g

150 g

150 g

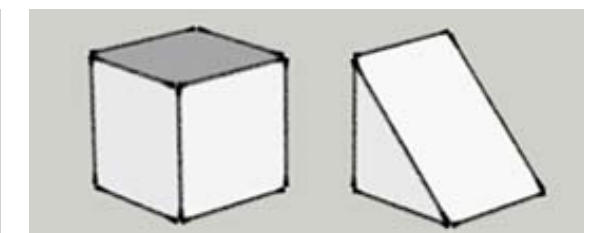
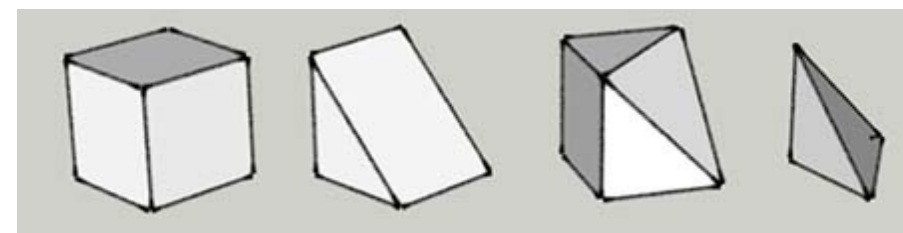
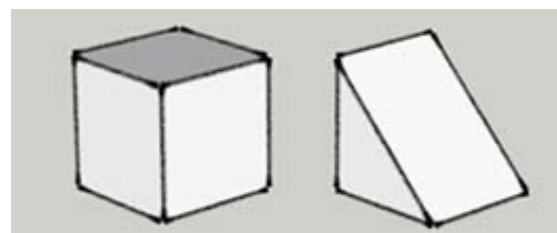
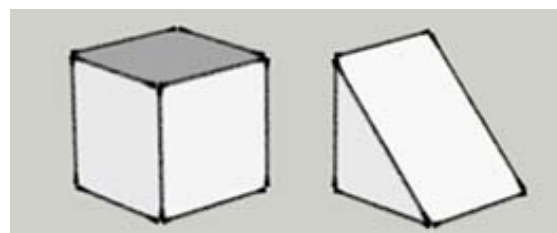



How we pack the JollyHeap construction blocks

1-99

AVAILABLE PACKS ARE COMPATIBLE WITH SETS OF 50 AND 100. SIZE:

- 64x27x64 weight 8kg
- 64x54x64 weight 17kg
- for the demonstration 12 (pcs.) we have a representative box

We have [high product availability](#).

We also work in a [dropshipping model](#).





You can find us here:



<https://jollyheap.com/>

<https://www.facebook.com/jollyheapt toys>

<https://www.instagram.com/jollyheap/>

<https://pl.linkedin.com/company/jollyheap>

<https://www.youtube.com/@JollyHeap>



**We look forward to doing business
with you**

JollyHeap

Svitlana Sapunova

Alei Led 4

55-020 Rzeplin, near Wrocław

POLAND



jollyheap.com